

BFS EC

čtyřhranné napojení

CHARAKTERISTIKA

- Radiální ventilátor se čtyřhranným napojením
- Pro použití v rozvodech větších délek
- Kompaktní ventilátor s vysokým výkonem a účinností, má pouze o něco větší rozměry než potrubí
- Nízká hladina akustického výkonu
- Ventilátor je určen pro dopravu čistého vzduchu bez prachu, mastnot, výparů chemikálií a dalšího znečištění
- Snadná instalace v libovolné poloze
- Pokud je ventilátor připojen na potrubí, může být instalován ve venkovním nebo vlhkém prostředí
- **Splňuje ErP 2018**

KONSTRUKCE

- Skříň ventilátoru je vyrobena z pozinkované oceli
- Oběžné kolo s dozadu zahnutými lopatkami
- Hrdla ventilátoru jsou vybavena gumovým těsněním

MOTOR

- **EC motory**
- Oběžné kolo s dozadu zahnutými lopatkami
- Vnější rotor motoru je vybaven bezúdržbovými zapouzdřenými kuličkovými ložisky
- Regulace rychlosti může být řízena vestavěným potenciometrem 0-10 V, nebo externí regulací
- Integrovaná tepelná ochrana motoru

INSTALACE

- Snadná instalace v libovolné poloze

ROZMĚRY

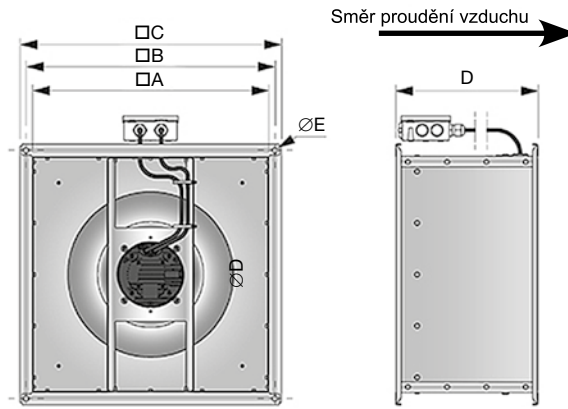

Typ	Rozměry [mm]				
	A	B	C	D	ØE
BFS400x400-EC	400	422	443	241	9
BFS450x450-EC	450	472	493	291	9
BFS500x500-EC	500	522	543	326	9
BFS600x600-EC	600	622	643	394	9
BFS700x700-EC	700	722	743	458	9
BFS750x750-EC	750	772	793	503	9
BFS850x850-EC	850	872	893	523	9

HLUK

BFS400x400B1-EC	Tot	63 Hz	125 Hz	250 Hz	500 Hz	1 kHz	2 kHz	4 kHz	8 kHz
Od sání Lw dB(A)	71	46	53	58	64	64	66	61	58
Od výfuku Lw dB(A)	74	50	55	60	65	66	71	65	60
Do prostoru Lw dB(A)	54	27	45	44	51	45	44	40	35
Do prostoru Lp dB(A)	47	20	38	37	44	38	37	33	28

BFS450x450C1-EC	Tot	63 Hz	125 Hz	250 Hz	500 Hz	1 kHz	2 kHz	4 kHz	8 kHz
Od sání Lw dB(A)	70	54	57	63	64	61	64	60	57
Od výfuku Lw dB(A)	74	63	61	70	64	66	67	62	60
Do prostoru Lw dB(A)	54	37	39	48	49	48	45	41	35
Do prostoru Lp dB(A)	47	30	32	41	42	41	38	34	28

BFS500x500B1-EC	Tot	63 Hz	125 Hz	250 Hz	500 Hz	1 kHz	2 kHz	4 kHz	8 kHz
Od sání Lw dB(A)	71	54	62	63	63	62	65	62	55
Od výfuku Lw dB(A)	72	61	63	65	60	65	66	63	57
Do prostoru Lw dB(A)	54	31	41	48	51	45	42	38	30
Do prostoru Lp dB(A)	47	24	34	41	44	38	35	31	23

BFS500x500D1-EC	Tot	63 Hz	125 Hz	250 Hz	500 Hz	1 kHz	2 kHz	4 kHz	8 kHz
Od sání Lw dB(A)	72	54	63	63	63	64	67	64	58
Od výfuku Lw dB(A)	74	62	65	67	62	66	67	64	59
Do prostoru Lw dB(A)	54	35	42	49	48	46	43	39	32
Do prostoru Lp dB(A)	47	28	35	42	41	39	36	32	25

* Hlukové údaje měřeny v nedefinovaném prostoru ve vzdálenosti 3 m, pro statický tlak 200 Pa

** Lp: hladina akustického tlaku dB(A) ve vzdálenosti 3 m

*** Lw: hladina akustického výkonu dB(A)

BFS500x500D3-EC	Tot	63 Hz	125 Hz	250 Hz	500 Hz	1 kHz	2 kHz	4 kHz	8 kHz
Od sání Lw dB(A)	77	60	64	71	68	68	71	68	64
Od výfuku Lw dB(A)	79	68	69	71	68	72	72	69	66
Do prostoru Lw dB(A)	57	39	43	52	52	51	47	42	34
Do prostoru Lp dB(A)	50	32	36	45	45	44	40	35	27

BFS600x600B1-EC	Tot	63 Hz	125 Hz	250 Hz	500 Hz	1 kHz	2 kHz	4 kHz	8 kHz
Od sání Lw dB(A)	74	54	69	64	64	68	67	63	55
Od výfuku Lw dB(A)	79	65	71	74	72	70	71	66	57
Do prostoru Lw dB(A)	55	34	41	51	48	46	44	40	31
Do prostoru Lp dB(A)	48	27	34	44	41	39	37	33	24

BFS600x600B3-EC	Tot	63 Hz	125 Hz	250 Hz	500 Hz	1 kHz	2 kHz	4 kHz	8 kHz
Od sání Lw dB(A)	77	61	70	69	68	72	70	66	57
Od výfuku Lw dB(A)	80	67	72	72	65	74	73	69	61
Do prostoru Lw dB(A)	54	34	40	48	48	48	45	41	33
Do prostoru Lp dB(A)	47	27	33	41	41	41	38	34	26

BFS700x700B1-EC	Tot	63 Hz	125 Hz	250 Hz	500 Hz	1 kHz	2 kHz	4 kHz	8 kHz
Od sání Lw dB(A)	75	59	67	65	67	69	68	64	57
Od výfuku Lw dB(A)	80	69	71	67	70	76	72	67	62
Do prostoru Lw dB(A)	55	35	45	52	47	47	41	36	32
Do prostoru Lp dB(A)	48	28	38	45	40	40	34	29	25

BFS700x700B3-EC	Tot	63 Hz	125 Hz	250 Hz	500 Hz	1 kHz	2 kHz	4 kHz	8 kHz
Od sání Lw dB(A)	76	59	68	67	68	70	69	66	59
Od výfuku Lw dB(A)	82	69	73	69	72	78	73	68	63
Do prostoru Lw dB(A)	56	37	46	53	49	47	42	38	33
Do prostoru Lp dB(A)	49	30	39	46	42	40	35	31	26

BFS700x700D3-EC	Tot	63 Hz	125 Hz	250 Hz	500 Hz	1 kHz	2 kHz	4 kHz	8 kHz
Od sání Lw dB(A)	79	62	69	70	71	74	72	69	63
Od výfuku Lw dB(A)	85	71	74	72	75	82	78	74	67
Do prostoru Lw dB(A)	60	41	50	57	53	51	46	43	36
Do prostoru Lp dB(A)	53	34	43	50	46	44	39	36	29

BFS750x750A3-EC	Tot	63 Hz	125 Hz	250 Hz	500 Hz	1 kHz	2 kHz	4 kHz	8 kHz
Od sání Lw dB(A)	74	60	64	63	63	69	67	63	57
Od výfuku Lw dB(A)	74	64	65	64	66	69	66	63	56
Do prostoru Lw dB(A)	55	38	43	53	48	47	41	36	31
Do prostoru Lp dB(A)	48	31	36	46	41	40	34	29	24

BFS750x750E3-EC	Tot	63 Hz	125 Hz	250 Hz	500 Hz	1 kHz	2 kHz	4 kHz	8 kHz
Od sání Lw dB(A)	81	67	70	69	70	76	76	72	66
Od výfuku Lw dB(A)	82	70	72	69	72	77	75	72	65
Do prostoru Lw dB(A)	63	41	50	61	55	55	50	45	37
Do prostoru Lp dB(A)	56	34	43	54	48	48	43	38	30

BFS850x850D3-EC	Tot	63 Hz	125 Hz	250 Hz	500 Hz	1 kHz	2 kHz	4 kHz	8 kHz
Od sání Lw dB(A)	78	64	68	70	68	73	71	66	59
Od výfuku Lw dB(A)	81	73	75	74	74	74	71	66	56
Do prostoru Lw dB(A)	59	44	46	56	52	49	42	37	31
Do prostoru Lp dB(A)	52	37	39	49	45	42	35	30	24

BFS850x850F3-EC	Tot	63 Hz	125 Hz	250 Hz	500 Hz	1 kHz	2 kHz	4 kHz	8 kHz
Od sání Lw dB(A)	82	68	73	72	73	77	75	72	65
Od výfuku Lw dB(A)	88	78	84	78	79	80	76	71	63
Do prostoru Lw dB(A)	56	42	43	53	50	46	40	33	30
Do prostoru Lp dB(A)	49	35	36	46	43	39	33	26	23

* Hlukové údaje měřeny v nedefinovaném prostoru ve vzdálenosti 3 m, pro statický tlak 200 Pa

** Lp: hladina akustického tlaku dB(A) ve vzdálenosti 3 m

*** Lw: hladina akustického výkonu dB(A)

BFS400x400B1-EC

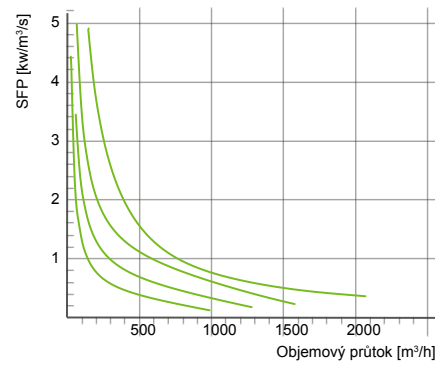
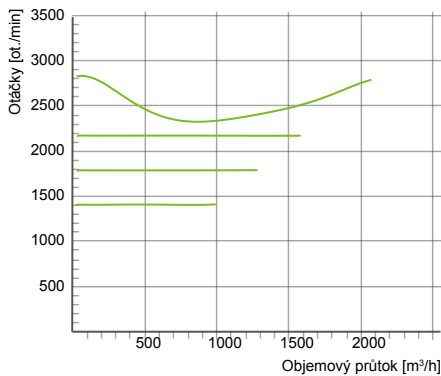
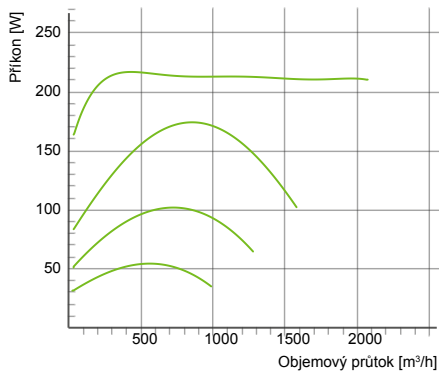
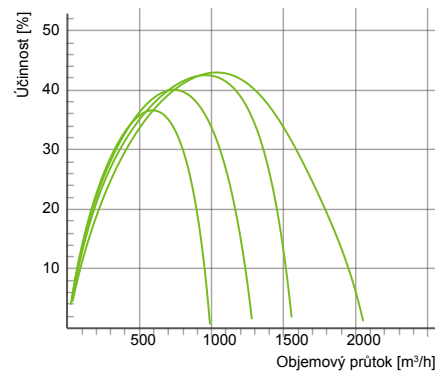
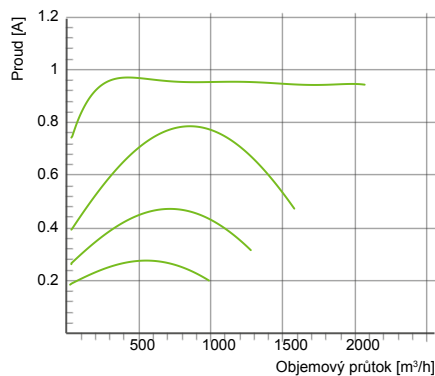
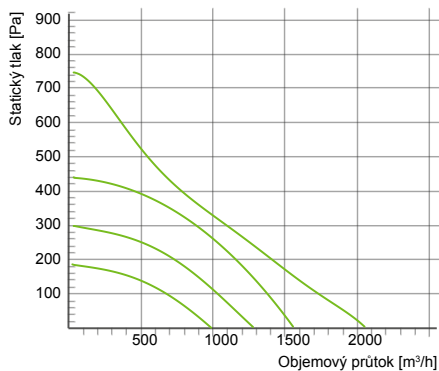

Typ	Napájení [V/Hz]	Hmotnost [kg]	Příkon [W]	Proud [A]*	IP/CL	Otáčky [ot./min]	Teplota [°C]**	Napojení [mm]	Max. průtok [m³/h]	Max. tlak [Pa]
BFS400x400B1-EC	230/50	11,5	217	0,97	54/F	2370	60	400x400	2063	755

* Proud, když je ventilátor regulován

** Maximální teplota dopravovaného vzduchu, když je ventilátor regulován

BFS450x450C1-EC

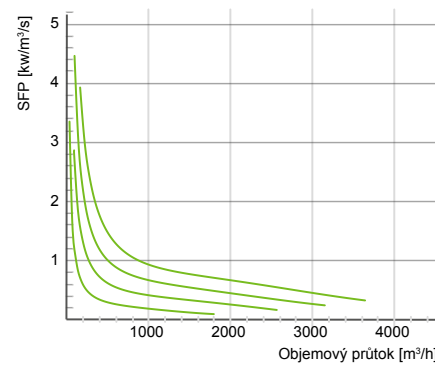
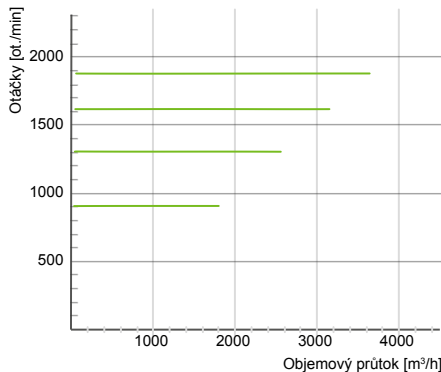
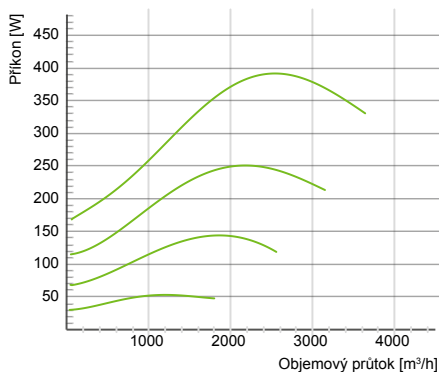
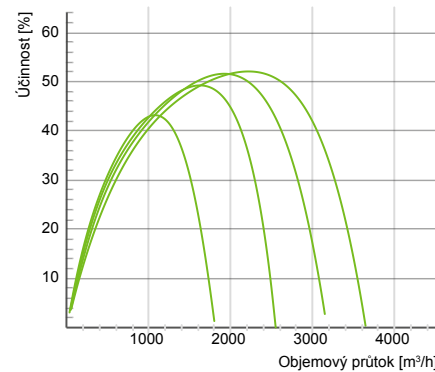
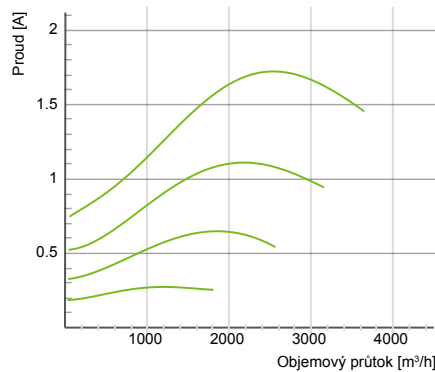
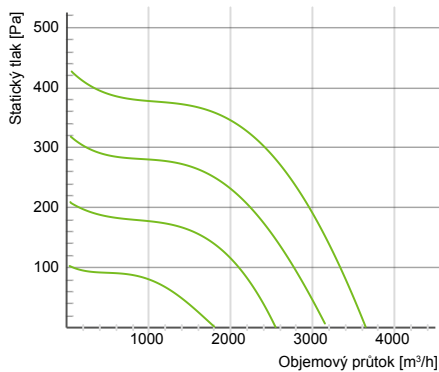

Typ	Napájení [V/Hz]	Hmotnost [kg]	Příkon [W]	Proud [A]*	IP/CL	Otáčky [ot./min]	Teplota [°C]**	Napojení [mm]	Max. průtok [m³/h]	Max. tlak [Pa]
BFS450x450C1-EC	230/50	13,5	400	1,77	54/F	1880	60	450x450	3650	430

* Proud, když je ventilátor regulován

** Maximální teplota dopravovaného vzduchu, když je ventilátor regulován

BFS500x500B1-EC

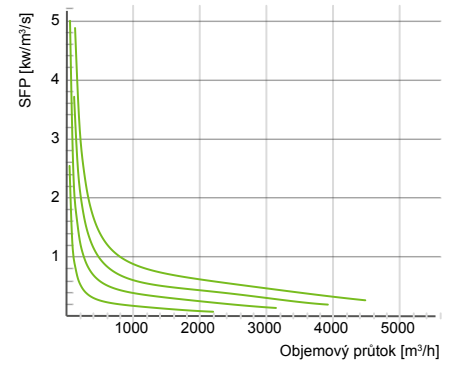
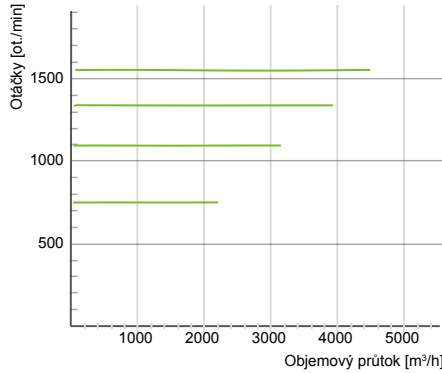
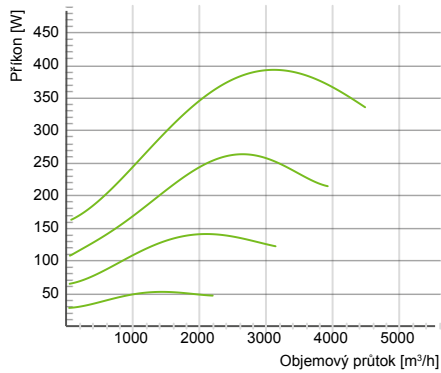
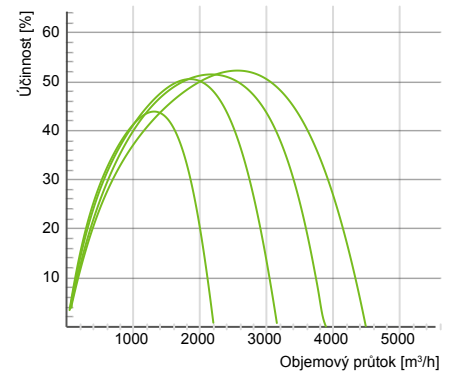
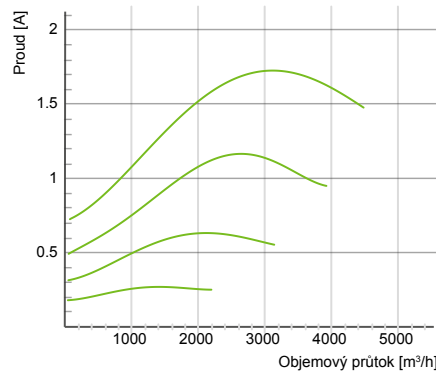
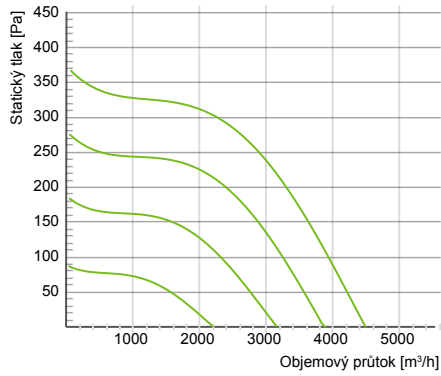

BFS500x500D1-EC

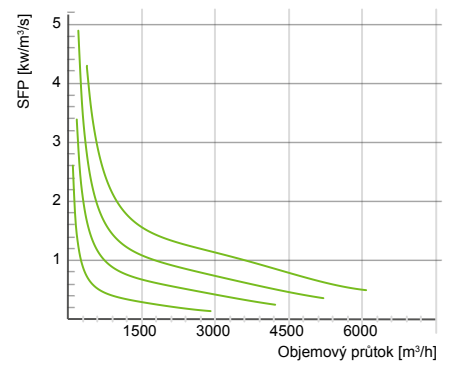
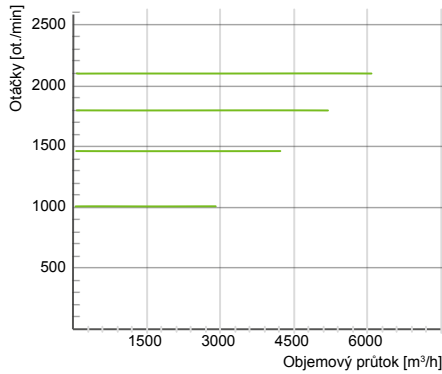
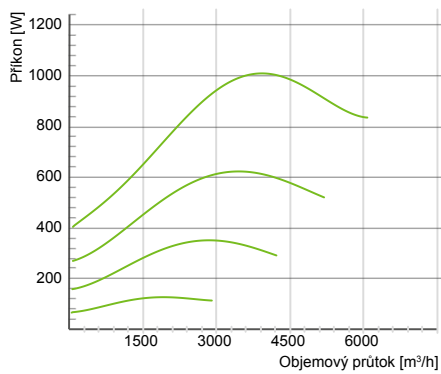
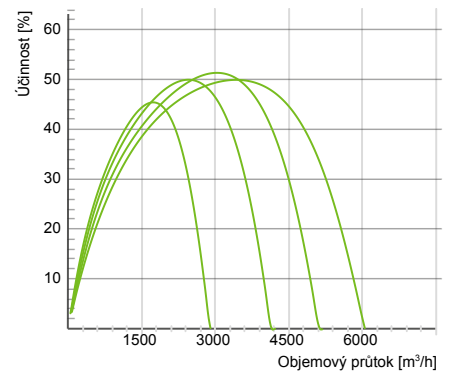
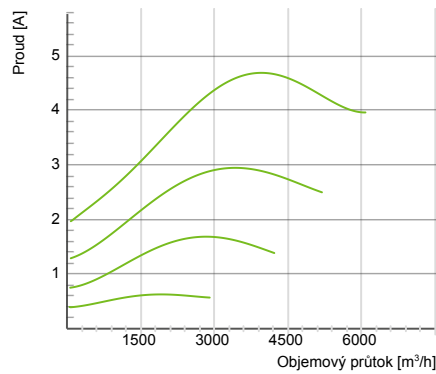
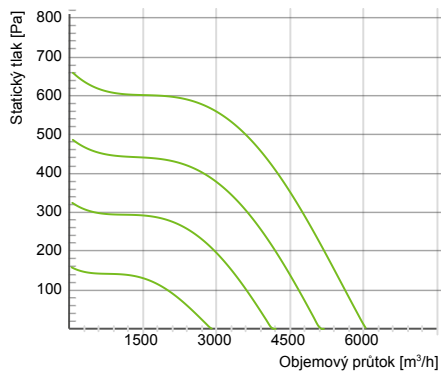

BFS500x500D3-EC

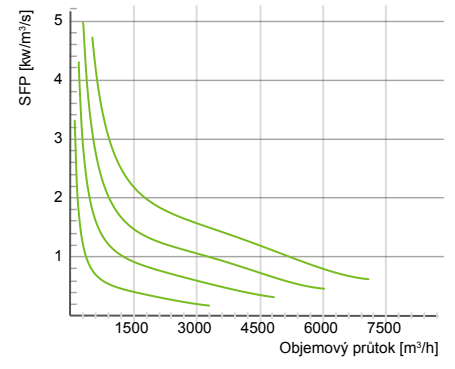
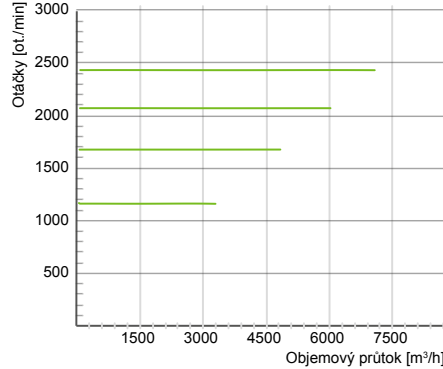
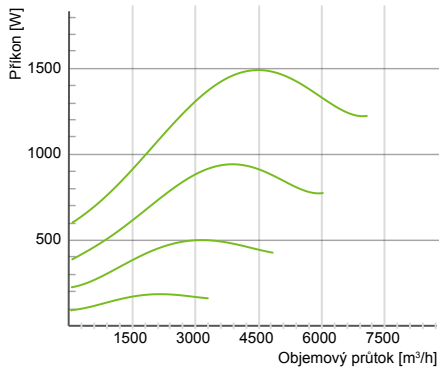
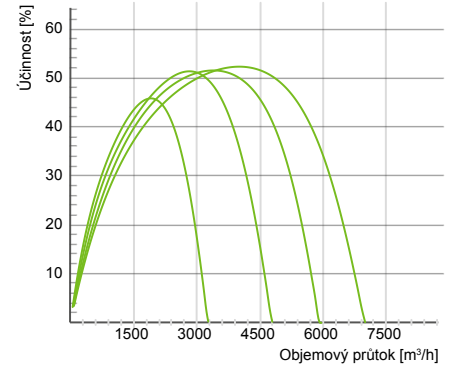
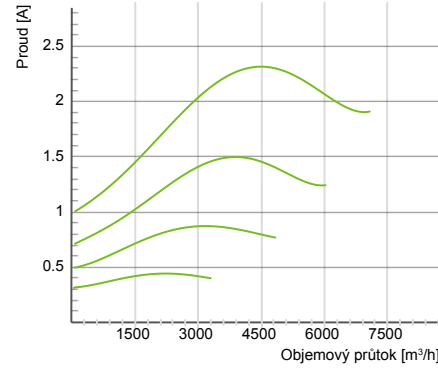
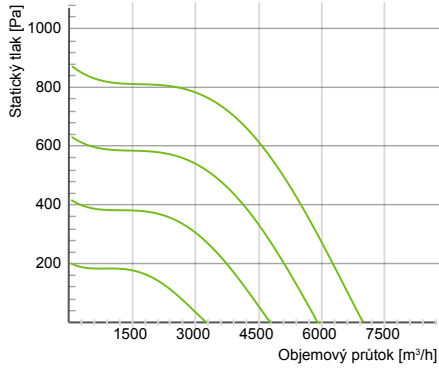

Typ	Napájení [V/Hz]	Hmotnost [kg]	Příkon [W]	Proud [A]*	IP/CL	Otáčky [ot./min]	Teplota [°C]**	Napojení [mm]	Max. průtok [m³/h]	Max. tlak [Pa]
BFS500x500B1-EC	230/50	18,5	398	1,75	54/F	1540	55	500x500	4486	371
BFS500x500D1-EC	230/50	18,5	1020	4,72	54/F	2100	55	500x500	6041	663
BFS500x500D3-EC	400/50	18,5	1520	2,35	54/F	2430	60	500x500	6980	877

* Proud, když je ventilátor regulován

** Maximální teplota dopravovaného vzduchu, když je ventilátor regulován

BFS600x600B1-EC

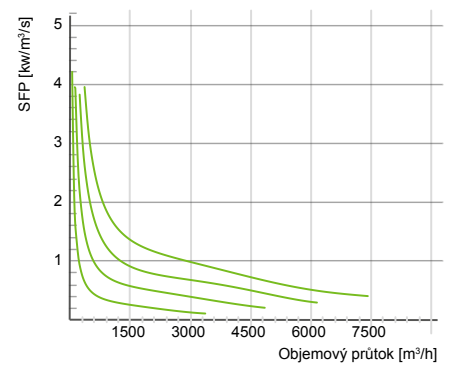
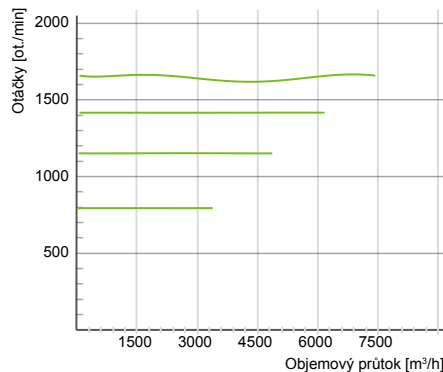
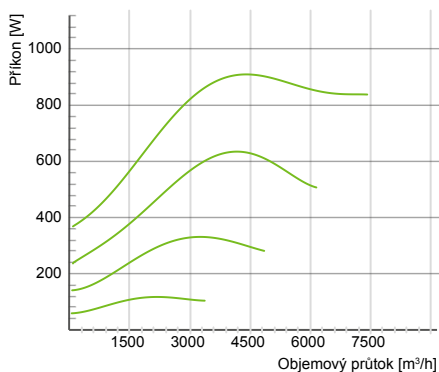
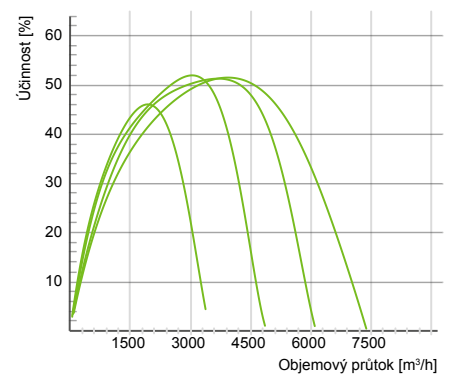
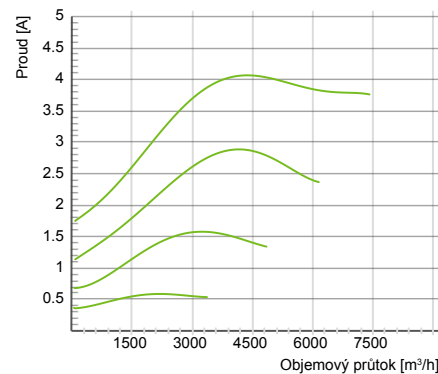
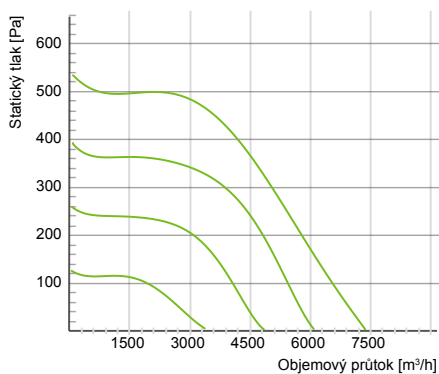

BFS600x600B3-EC

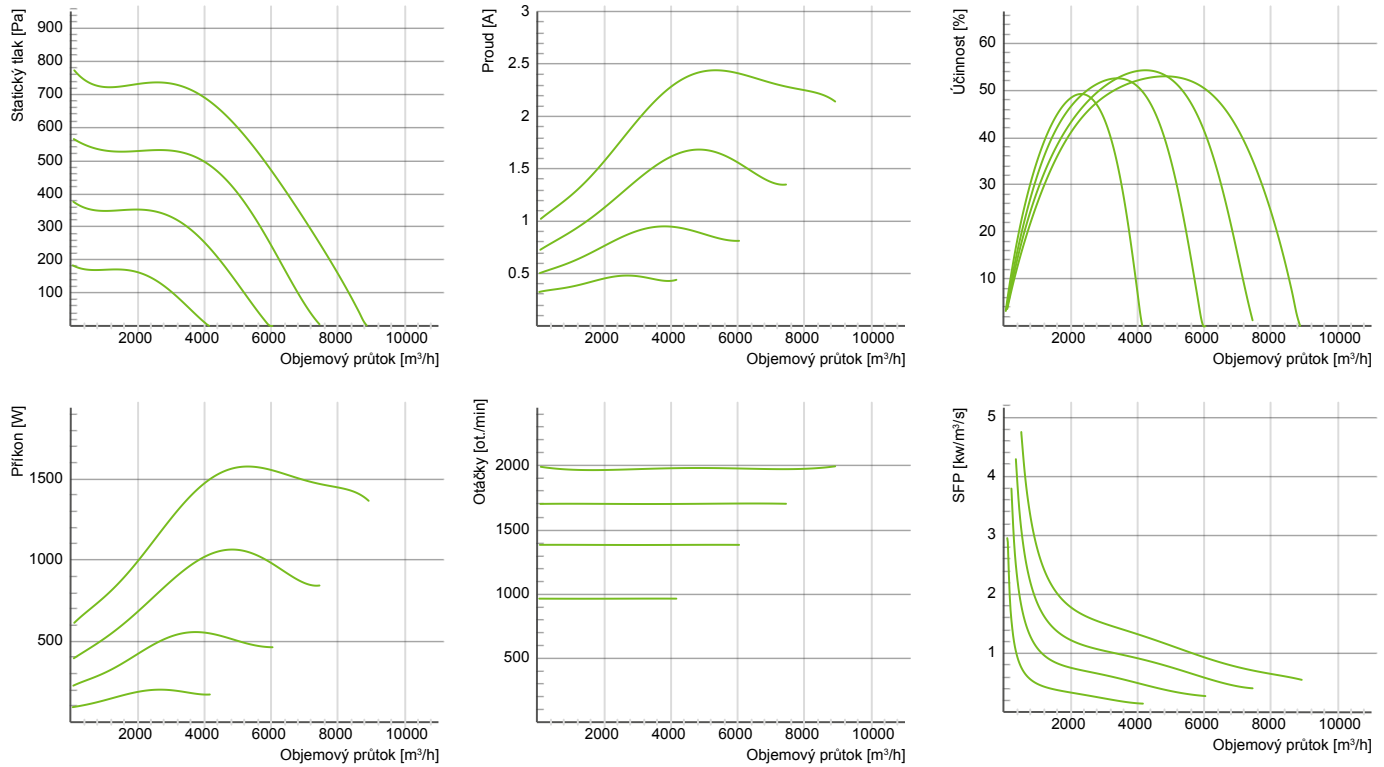

Typ	Napájení [V/Hz]	Hmotnost [kg]	Příkon [W]	Proud [A]*	IP/CL	Otáčky [ot./min]	Teplota [°C]**	Napojení [mm]	Max. průtok [m³/h]	Max. tlak [Pa]
BFS600x600B1-EC	230/50	27,9	905	4,04	54/F	1650	40	600x600	7394	539
BFS600x600B3-EC	400/50	27,1	1590	2,45	54/F	1980	50	600x600	8838	781

* Proud, když je ventilátor regulován

** Maximální teplota dopravovaného vzduchu, když je ventilátor regulován

BFS700x700B1-EC

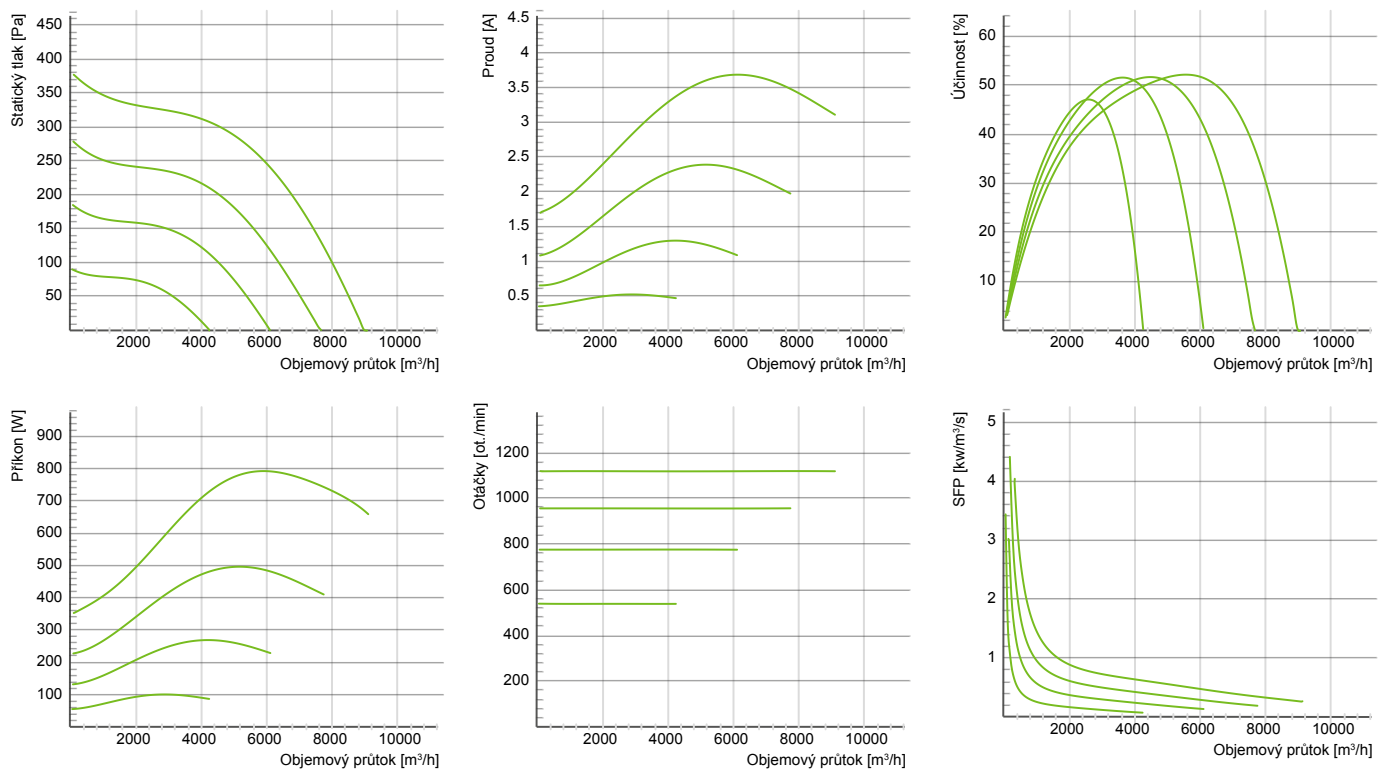

BFS700x700B3-EC

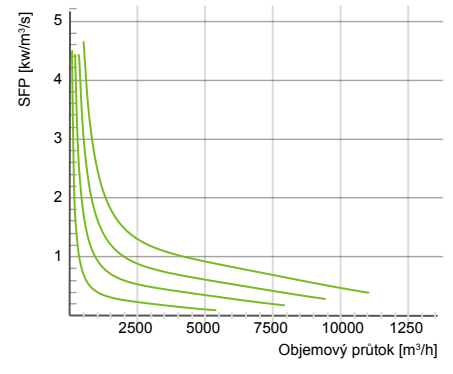
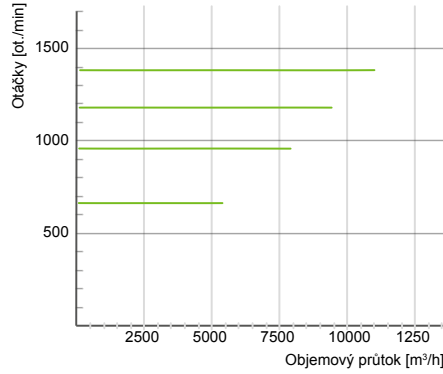
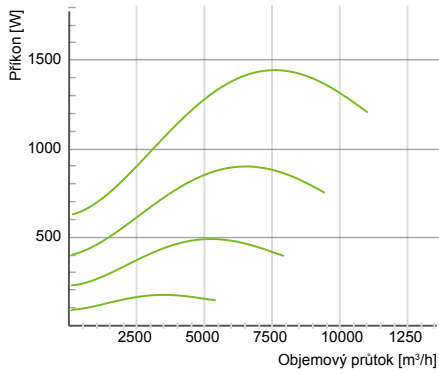
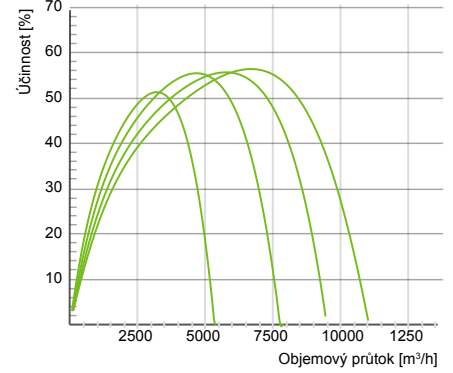
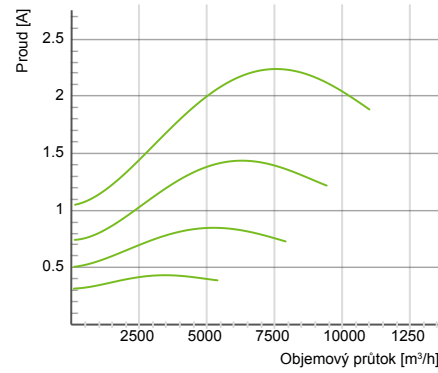
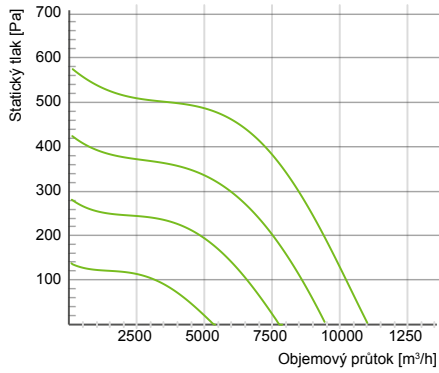

BFS700x700D3-EC

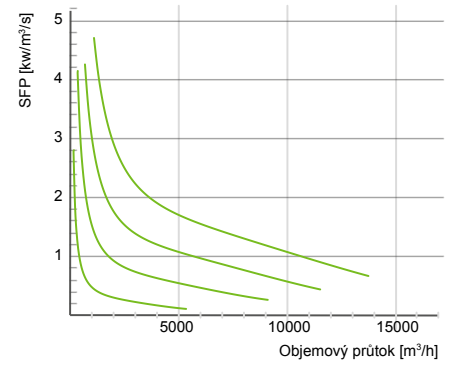
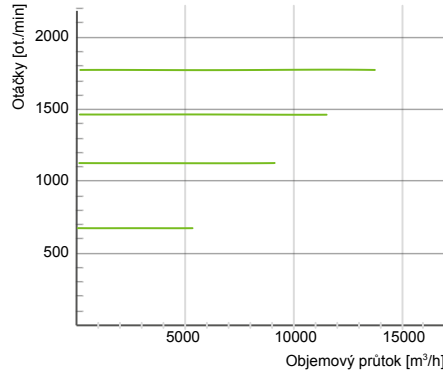
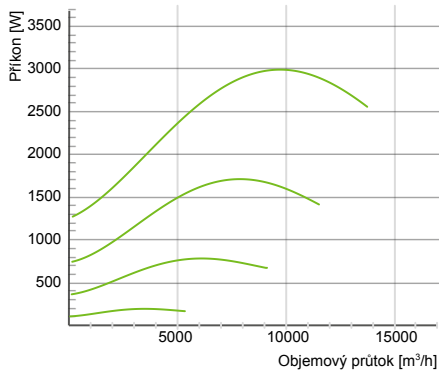
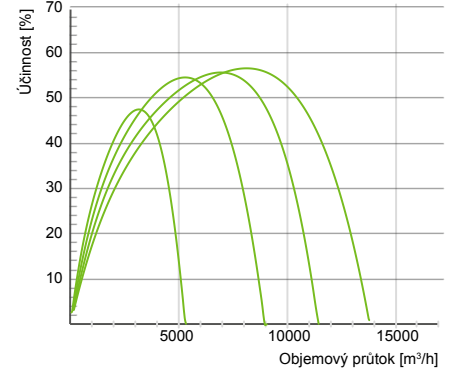
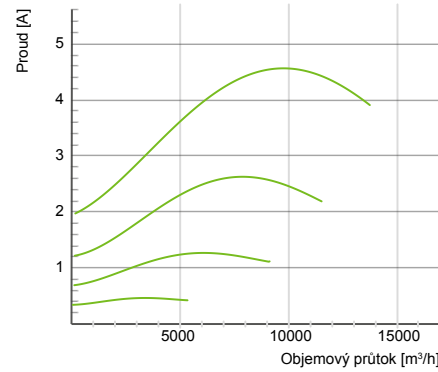
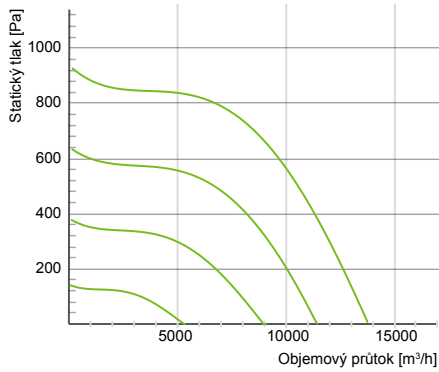

Typ	Napájení [V/Hz]	Hmotnost [kg]	Příkon [W]	Proud [A]*	IP/CL	Otáčky [ot./min]	Teplota [°C]**	Napojení [mm]	Max. průtok [m³/h]	Max. tlak [Pa]
BFS700x700B1-EC	230/50	37,4	788	3,65	54/F	1120	55	700x700	8975	380
BFS700x700B3-EC	400/50	37,4	1450	2,25	54/F	1380	40	700x700	11045	580
BFS700x700D3-EC	400/50	44,2	2980	4,54	54/F	1770	60	700x700	13806	934

* Proud, když je ventilátor regulován

** Maximální teplota dopravovaného vzduchu, když je ventilátor regulován

BFS750x750A3-EC

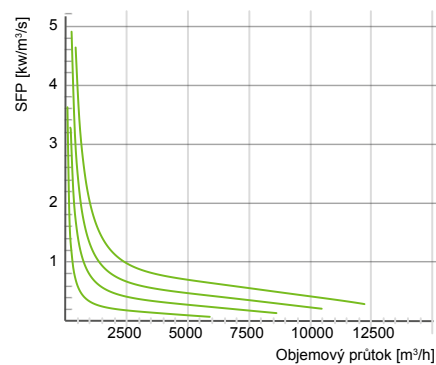
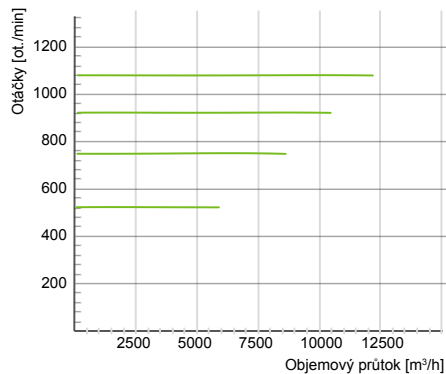
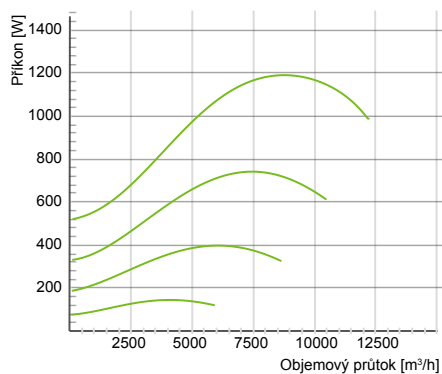
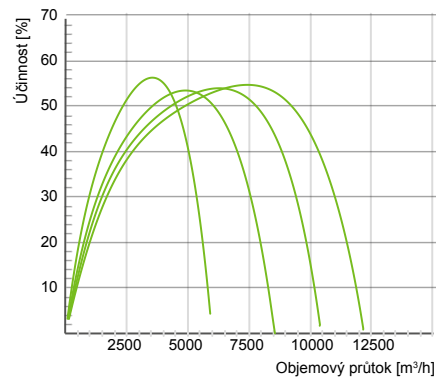
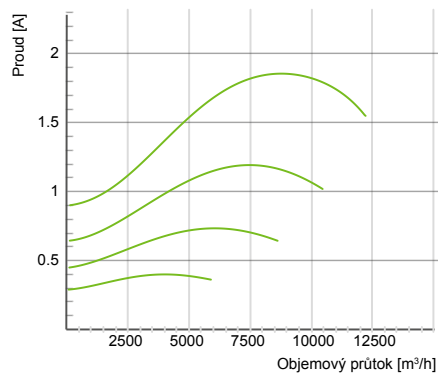
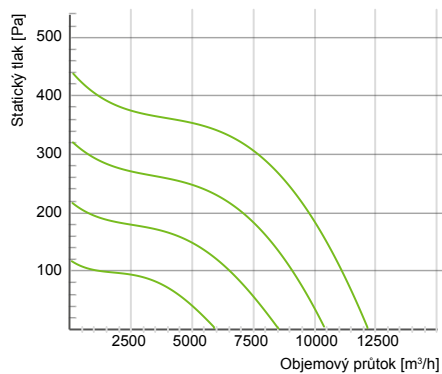

BFS750x750E3-EC

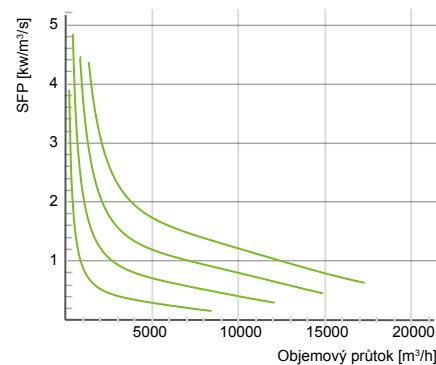
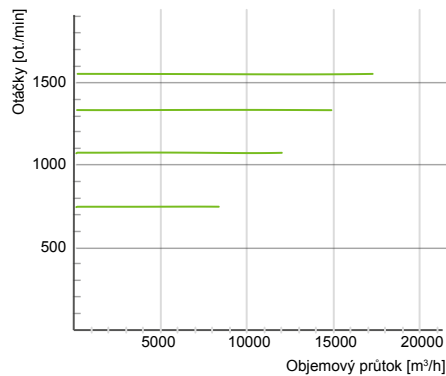
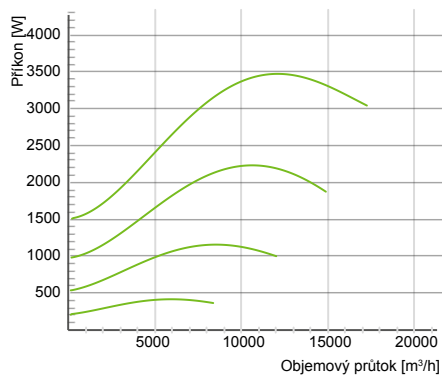
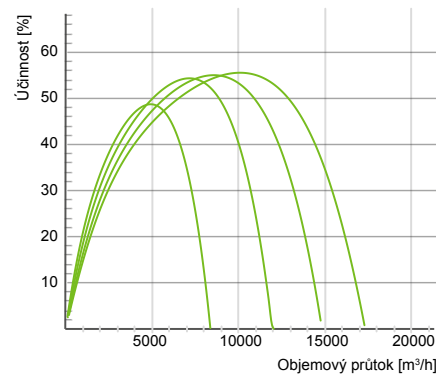
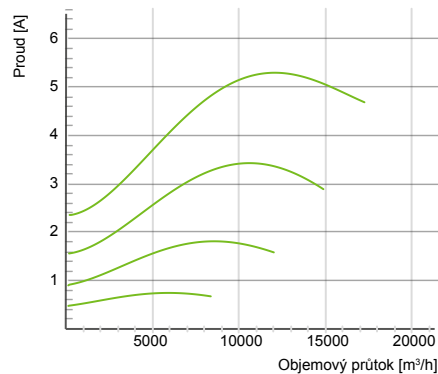
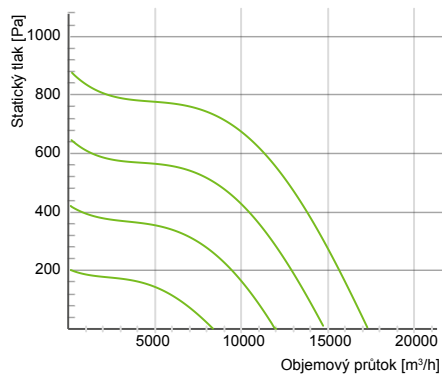

Typ	Napájení [V/Hz]	Hmotnost [kg]	Příkon [W]	Proud [A]*	IP/CL	Otáčky [ot./min]	Teplota [°C]**	Napojení [mm]	Max. průtok [m³/h]	Max. tlak [Pa]
BFS750x750A3-EC	400/50	42	1190	1,86	54/F	1080	40	750x750	12204	437
BFS750x750E3-EC	400/50	50,2	3500	5,4	54/F	1550	50	750x750	17312	876

* Proud, když je ventilátor regulován

** Maximální teplota dopravovaného vzduchu, když je ventilátor regulován

BFS850x850D3-EC

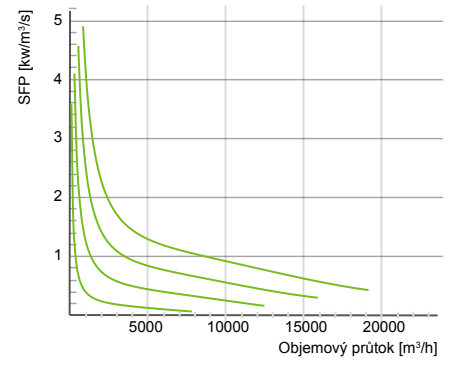
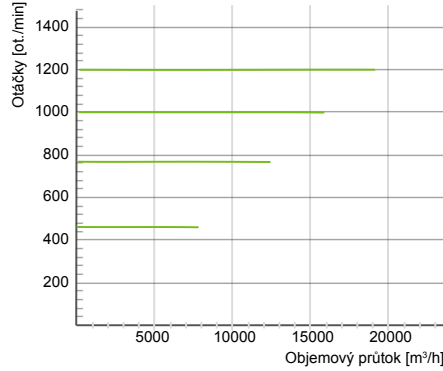
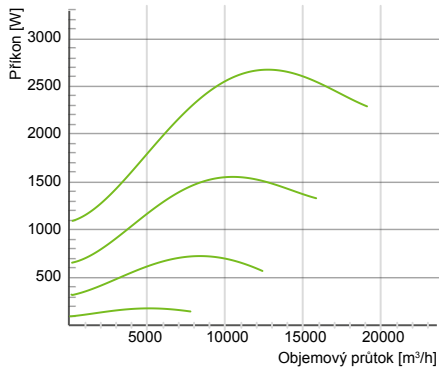
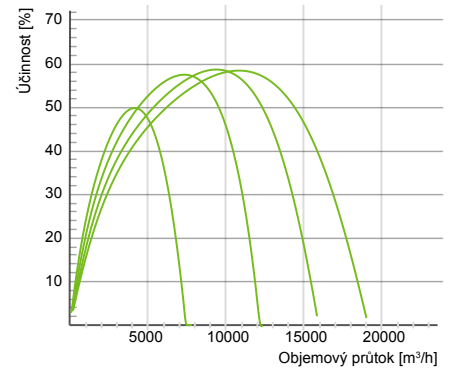
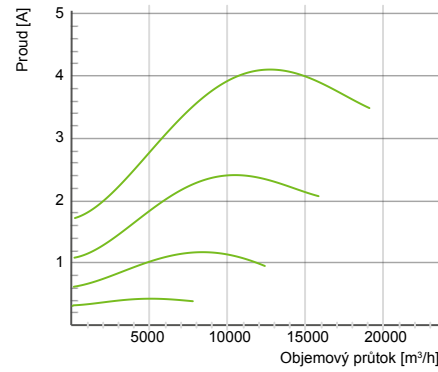
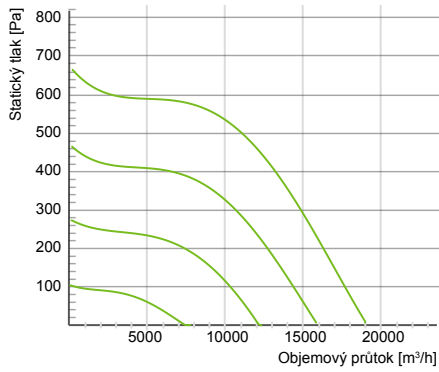

BFS850x850F3-EC

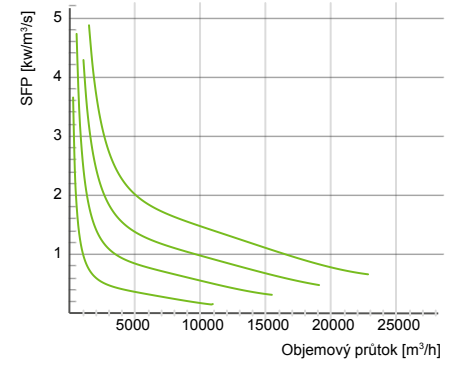
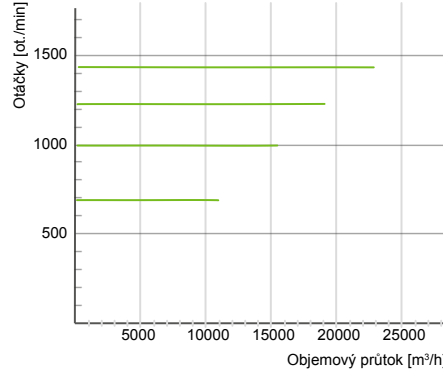
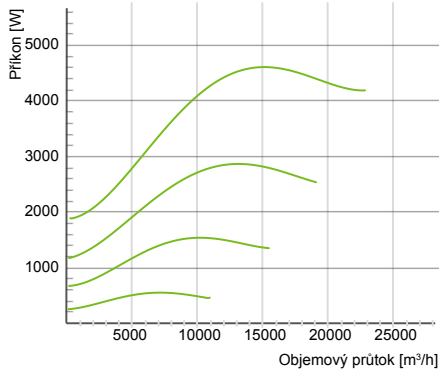
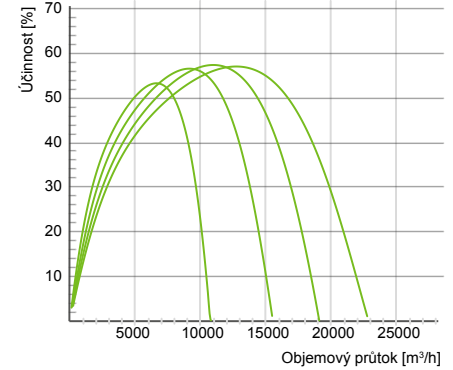
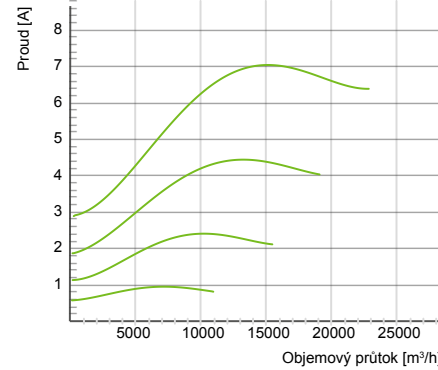
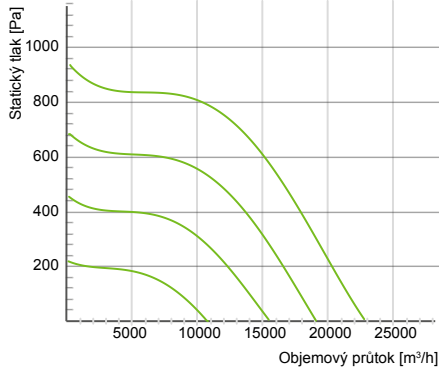

Typ	Napájení [V/Hz]	Hmotnost [kg]	Příkon [W]	Proud [A]*	IP/CL	Otáčky [ot./min]	Teplota [°C]**	Napojení [mm]	Max. průtok [m³/h]	Max. tlak [Pa]
BFS850x850D3-EC	400/50	73,8	2740	4,17	54/F	1200	60	850x850	19112	664
BFS850x850F3-EC	400/50	73,8	4690	7,1	54/F	1430	40	850x850	22853	936

* Proud, když je ventilátor regulován

** Maximální teplota dopravovaného vzduchu, když je ventilátor regulován

PŘÍSLUŠENSTVÍ REGULACE

Typ	Regulace
BFS400x400B1-EC	MS EC
BFS450x450C1-EC	MS EC
BFS500x500B1-EC	MS EC
BFS500x500D1-EC	MS EC
BFS500x500D3-EC	MS EC
BFS600x600B1-EC	MS EC
BFS600x600B3-EC	MS EC
BFS700x700B1-EC	MS EC
BFS700x700B3-EC	MS EC
BFS700x700D3-EC	MS EC
BFS750x750A3-EC	MS EC
BFS750x750E3-EC	MS EC
BFS850x850D3-EC	MS EC
BFS850x850F3-EC	MS EC

MS EC – Manuální třírychlostní regulátor otáček EC motorů, 0–10 V. Min–max lze nastavit pomocí šroubů pod knoflíkem



SCHEMA ZAPOJENÍ

BFS400400B1-EC

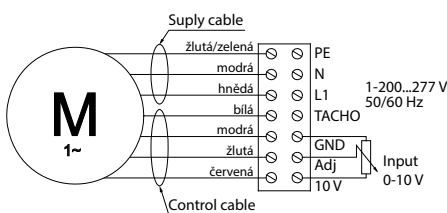

BFS450450C1-EC, BFS500500B1-EC

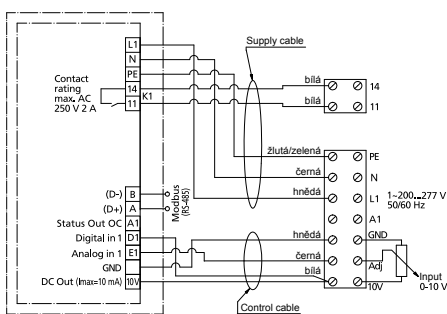

BFS500500D1-EC, BFS600600B1-EC, BFS700700B1-EC

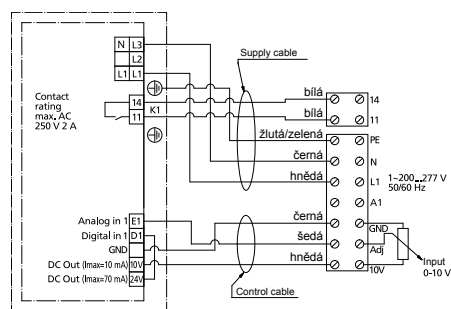

BFS500500D3-EC, BFS600600B3-EC, BFS700700B3-EC, BFS700700D3-EC, BFS750750A3-EC, BFS750750E3-EC, BFS850850D3-EC, BFS850850F3-EC

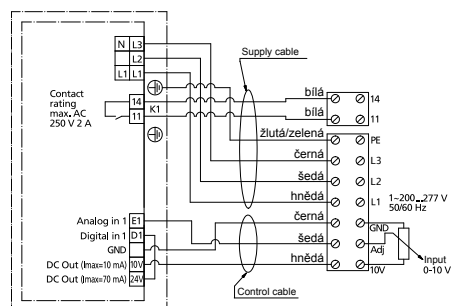

* Uvedená schémata zapojení jsou pouze orientační, vždy má vyšší prioritu schéma zapojení uvedené na výrobku

3

PŘÍSLUŠENSTVÍ

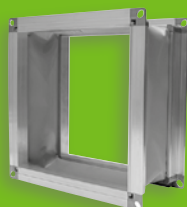

PSPH
Pružné spojení



PDZ-Z
Protidešťová žaluzie

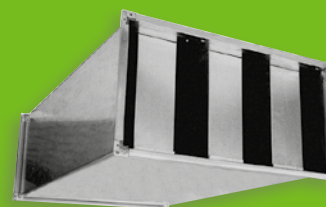

TH
Tlumič hluku

PŘÍKLAD ZNAČENÍ

BFS400400B1-EC

