



KVFU

CHARAKTERISTIKA

- Nástěnný radiální ventilátor s kruhovým napojením
- Kompaktní ventilátor s vysokým výkonem a účinností
- Lze použít ve vlhkém prostředí
- Snadná instalace v libovolné poloze
- **Splňuje ErP**

KONSTRUKCE

- Skříň ventilátoru je vyrobena z pozinkovaného ocelového plechu
- Oběžné kolo s dozadu zahnutými lopatkami
- Čtvercová montážní deska

MOTOR

- **AC motor**
- Vnější rotor motoru je vybaven bezúdržbovými zapouzdřenými kuličkovými ložisky
- Integrovaná tepelná ochrana motoru
- Třída izolace motoru F
- Lze regulovat transformátorovým nebo elektronickým regulátorem otáček

INSTALACE

- Připojení na kruhové potrubí

ROZMĚRY

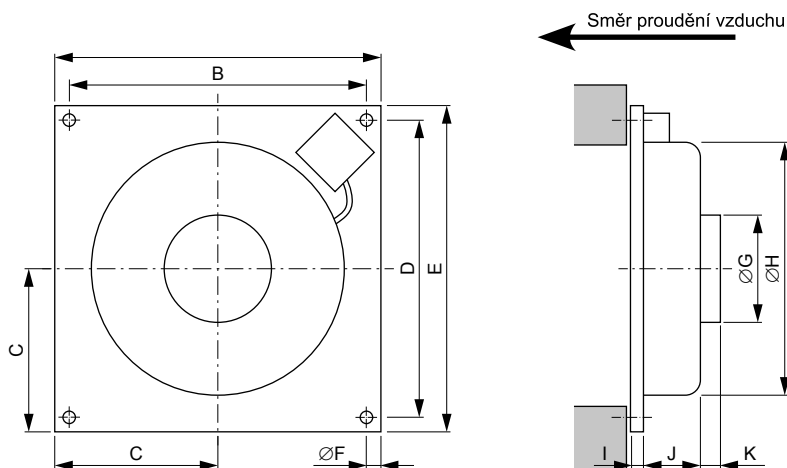

Typ	Rozměry v [mm]										
	A	B	C	D	E	ØF	ØG	ØH	I	J	K
KVFU100	310	295	140	295	310	6	100	240	7	80	24
KVFU125	310	295	140	295	310	6	125	240	7	80	24
KVFU160B	335	320	155	320	335	6	160	268	7	70	30
KVFU160C	400	385	195	385	400	6	160	342	10	92	26
KVFU200	400	385	195	385	400	6	200	342	10	83	34
KVFU250	400	385	195	385	400	6	250	342	10	83	33
KVFU315	460	445	225	445	460	6	315	400	12	112	34

HLUK

KVFU100A	Tot	63 Hz	125 Hz	250 Hz	500 Hz	1 kHz	2 kHz	4 kHz	8 kHz
Od sání Lw dB(A)	65	58	56	58	59	56	51	47	41
Od výfuku Lw dB(A)	62	36	40	46	55	59	55	47	39
Do prostoru Lw dB(A)	46	22	32	41	39	40	38	31	29
Do prostoru Lp dB(A)	39								

KVFU100C	Tot	63 Hz	125 Hz	250 Hz	500 Hz	1 kHz	2 kHz	4 kHz	8 kHz
Od sání Lw dB(A)	69	56	60	62	64	59	56	54	46
Od výfuku Lw dB(A)	66	36	44	59	59	63	60	53	43
Do prostoru Lw dB(A)	51	25	34	44	44	45	44	37	30
Do prostoru Lp dB(A)	44								

KVFU125A	Tot	63 Hz	125 Hz	250 Hz	500 Hz	1 kHz	2 kHz	4 kHz	8 kHz
Od sání Lw dB(A)	66	56	60	61	59	56	51	49	43
Od výfuku Lw dB(A)	61	34	41	47	53	58	54	48	38
Do prostoru Lw dB(A)	48	23	30	42	42	43	39	33	29
Do prostoru Lp dB(A)	41								

* Hlukové údaje měřeny v nedefinovaném prostoru ve vzdálenosti 3 m, pro statický tlak 200 Pa

** Lp: hladina akustického tlaku dB(A) ve vzdálenosti 3 m

*** Lw: hladina akustického výkonu dB(A)

KVFU125C	Tot	63 Hz	125 Hz	250 Hz	500 Hz	1 kHz	2 kHz	4 kHz	8 kHz
Od sání Lw dB(A)	68	54	60	63	63	59	57	56	50
Od výfuku Lw dB(A)	65	35	43	50	50	63	59	53	44
Do prostoru Lw dB(A)	51	22	31	45	45	46	43	38	31
Do prostoru Lp dB(A)	44								

KVFU160B	Tot	63 Hz	125 Hz	250 Hz	500 Hz	1 kHz	2 kHz	4 kHz	8 kHz
Od sání Lw dB(A)	65	51	54	58	59	56	56	54	51
Od výfuku Lw dB(A)	63	30	37	49	53	59	58	54	46
Do prostoru Lw dB(A)	50	20	36	48	36	40	40	36	30
Do prostoru Lp dB(A)	43								

KVFU160C	Tot	63 Hz	125 Hz	250 Hz	500 Hz	1 kHz	2 kHz	4 kHz	8 kHz
Od sání Lw dB(A)	72	54	60	67	67	63	60	60	53
Od výfuku Lw dB(A)	70	33	43	55	63	66	64	60	49
Do prostoru Lw dB(A)	50	17	34	40	46	44	41	37	29
Do prostoru Lp dB(A)	43								

KVFU200A	Tot	63 Hz	125 Hz	250 Hz	500 Hz	1 kHz	2 kHz	4 kHz	8 kHz
Od sání Lw dB(A)	75	50	61	69	71	67	63	60	53
Od výfuku Lw dB(A)	73	32	42	56	64	69	66	60	49
Do prostoru Lw dB(A)	54	33	32	42	47	50	47	47	33
Do prostoru Lp dB(A)	47								

KVFU200B	Tot	63 Hz	125 Hz	250 Hz	500 Hz	1 kHz	2 kHz	4 kHz	8 kHz
Od sání Lw dB(A)	71	53	61	67	65	62	60	59	55
Od výfuku Lw dB(A)	69	35	40	56	59	69	67	59	48
Do prostoru Lw dB(A)	50	23	41	39	42	46	39	40	31
Do prostoru Lp dB(A)	43								

KVFU250A	Tot	63 Hz	125 Hz	250 Hz	500 Hz	1 kHz	2 kHz	4 kHz	8 kHz
Od sání Lw dB(A)	75	50	61	67	67	69	68	64	55
Od výfuku Lw dB(A)	72	45	42	59	62	75	73	63	49
Do prostoru Lw dB(A)	55	26	30	34	48	52	47	45	38
Do prostoru Lp dB(A)	48								

KVFU250B	Tot	63 Hz	125 Hz	250 Hz	500 Hz	1 kHz	2 kHz	4 kHz	8 kHz
Od sání Lw dB(A)	72	50	61	67	62	66	61	61	59
Od výfuku Lw dB(A)	70	45	42	59	58	73	68	58	49
Do prostoru Lw dB(A)	50	21	34	39	42	47	40	39	34
Do prostoru Lp dB(A)	43								

KVFU315C	Tot	63 Hz	125 Hz	250 Hz	500 Hz	1 kHz	2 kHz	4 kHz	8 kHz
Od sání Lw dB(A)	73	52	59	63	61	66	67	67	63
Od výfuku Lw dB(A)	71	48	56	58	58	73	69	59	48
Do prostoru Lw dB(A)	55	25	45	48	47	46	47	46	36
Do prostoru Lp dB(A)	48								

* Hlukové údaje měřeny v nedefinovaném prostoru ve vzdálenosti 3 m, pro statický tlak 200 Pa

** Lp: hladina akustického tlaku dB(A) ve vzdálenosti 3 m

*** Lw: hladina akustického výkonu dB(A)

**CHARAKTERISTIKA VENTILÁTORU
KVFU100A**

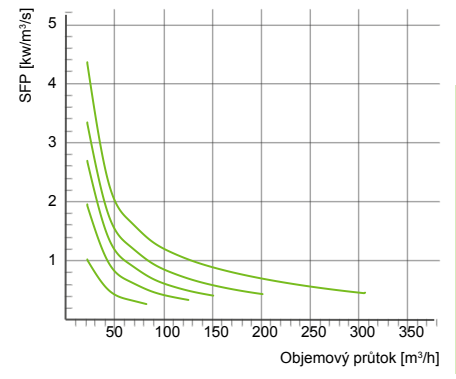
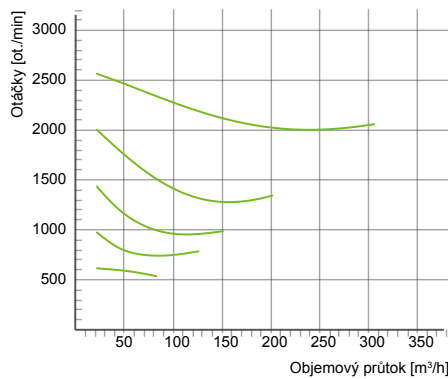
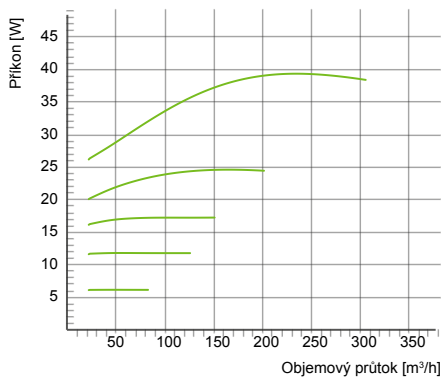
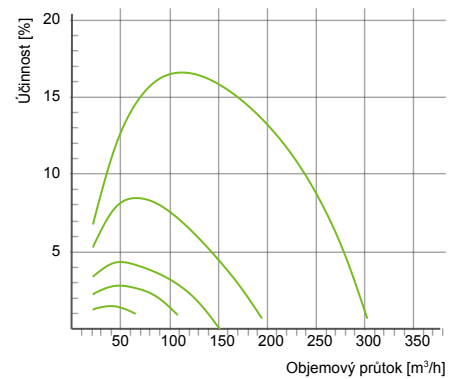
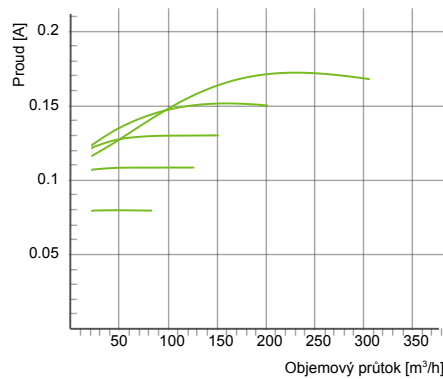
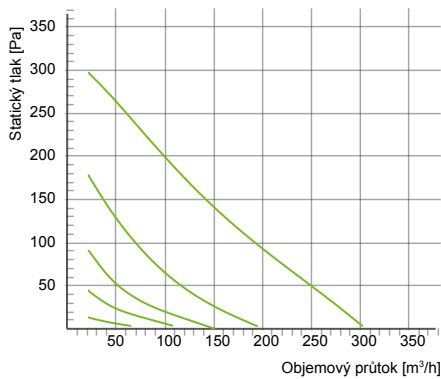

KVFU100C

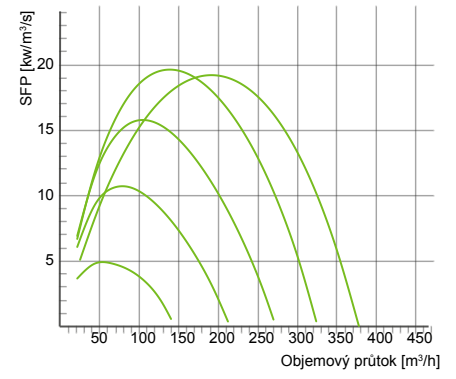
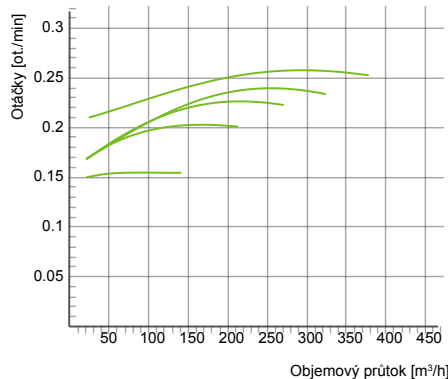
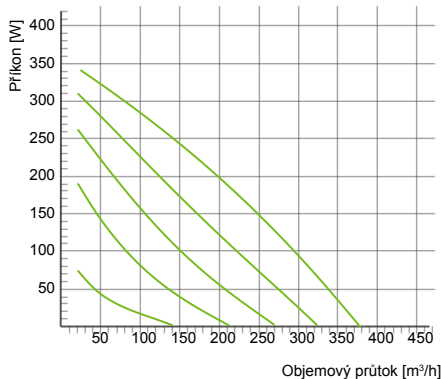
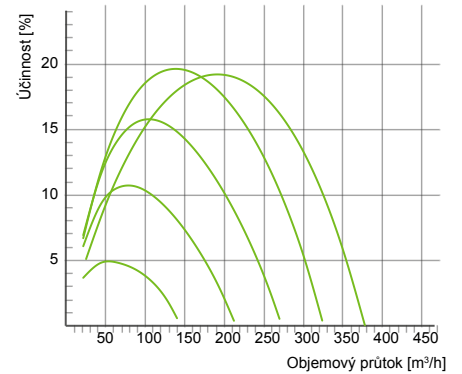
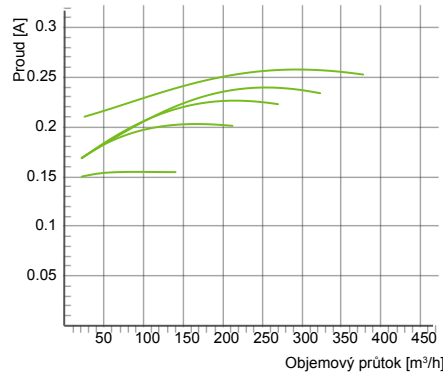
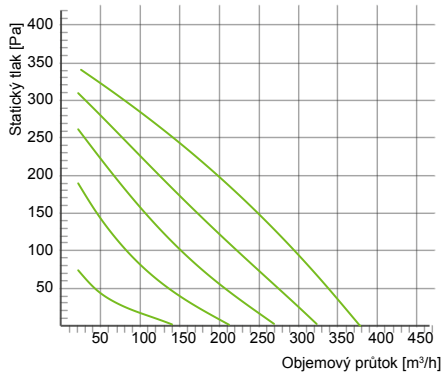

Typ	Napájení [V/Hz]	Hmotnost [kg]	Příkon [W]	Proud [A]	IP/CL	Otáčky [ot./min]	Teplota [°C]*	Napojení [mm]	Max. průtok [m³/h]	Max. tlak [Pa]	ErP 2018**
KVFU100A	230/50	2,5	39	0,17	44/F	2010	80	100	306	317	ANO
KVFU100C	230/50	2,5	59	0,26	44/F	2540	80	100	378	359	ANO

* Maximální teplota dopravovaného vzduchu, když je ventilátor regulován
** Pro splnění ErP 2018, je nutné použít SET-ERP2018

KVFU125A

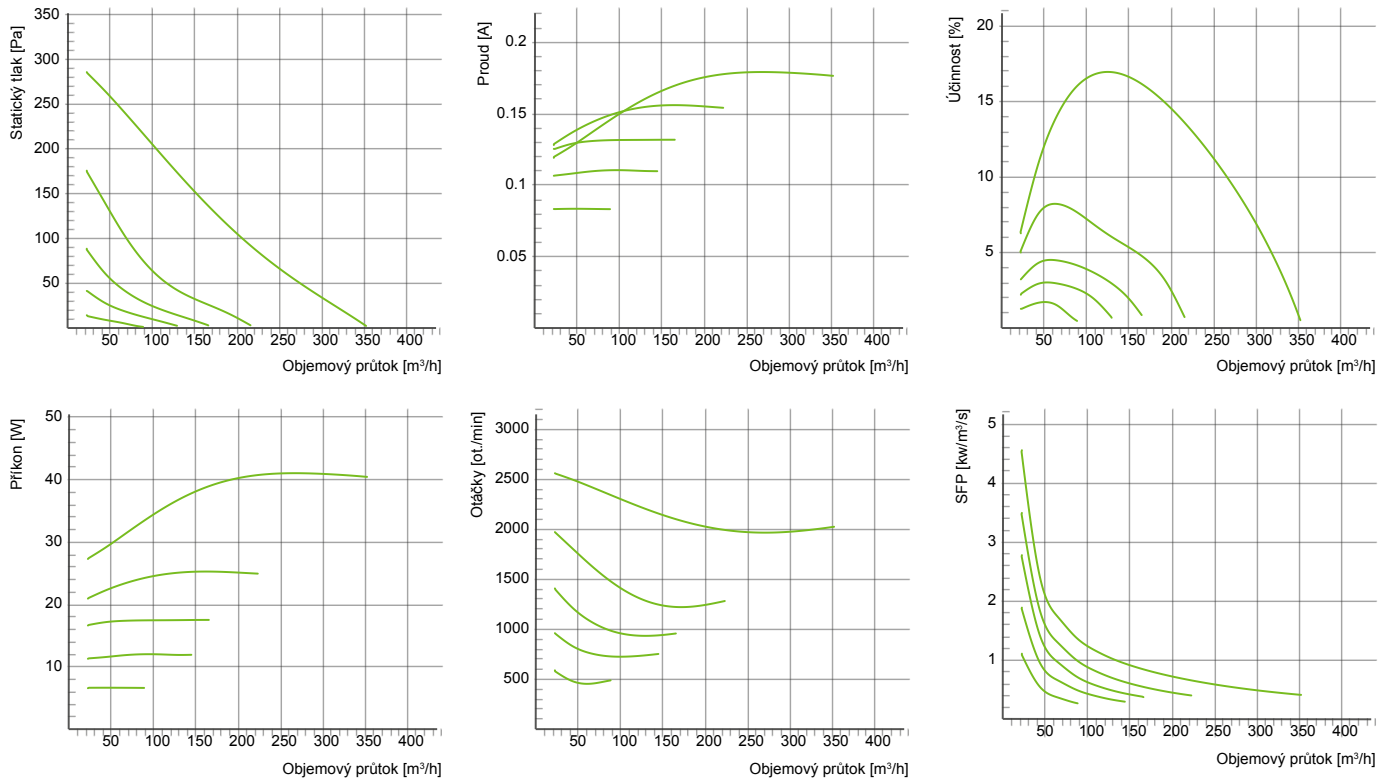

KVFU125C

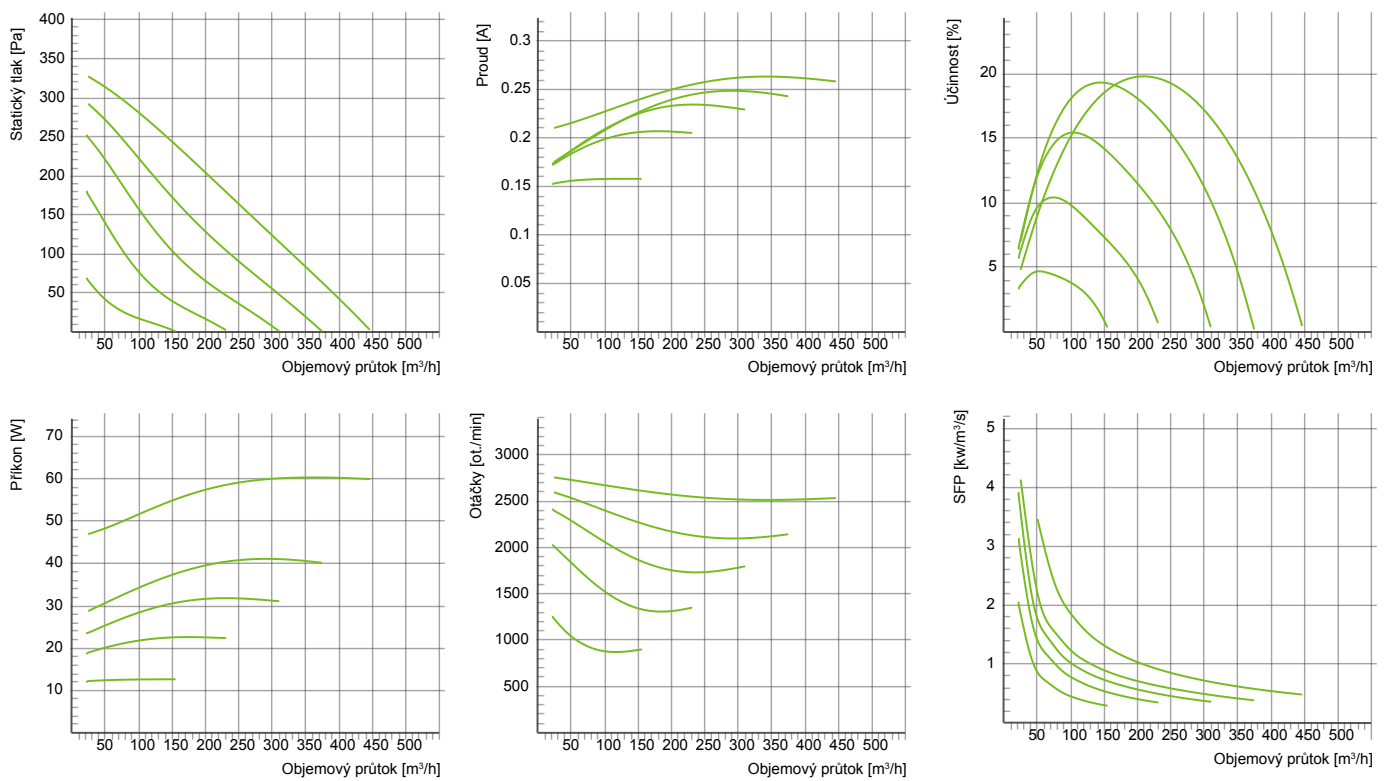

Typ	Napájení [V/Hz]	Hmotnost [kg]	Příkon [W]	Proud [A]	IP/CL	Otáčky [ot./min]	Teplota [°C]*	Napojení [mm]	Max. průtok [m³/h]	Max. tlak [Pa]	ErP 2018**
KVFU125A	230/50	2,5	41	0,18	44/F	1970	80	125	356	303	ANO
KVFU125C	230/50	2,5	60	0,26	44/F	2520	80	125	450	338	ANO

* Maximální teplota dopravovaného vzduchu, když je ventilátor regulován
** Pro splnění ErP 2018, je nutné použít SET-ERP2018

KVFU160B

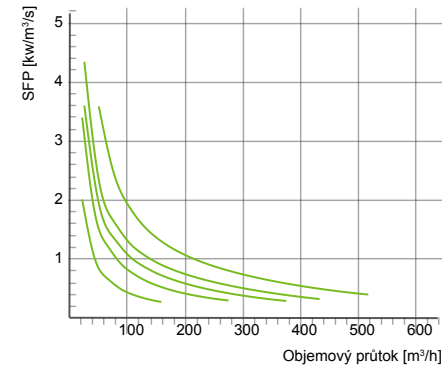
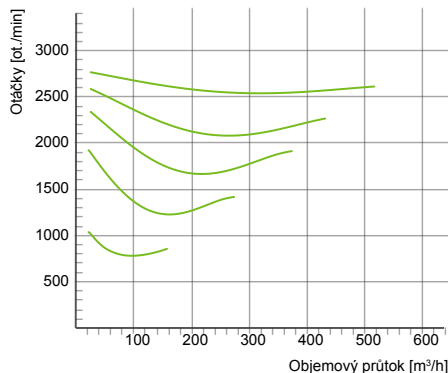
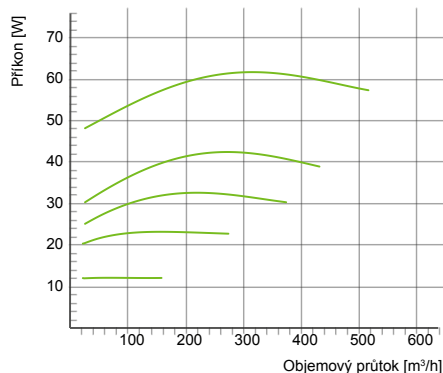
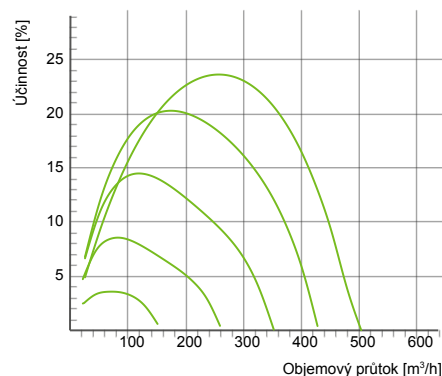
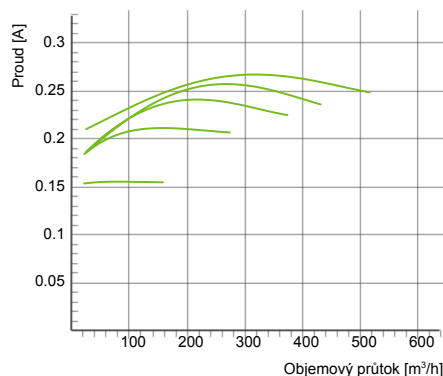
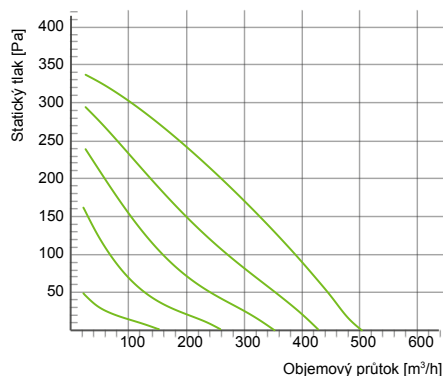

KVFU160C

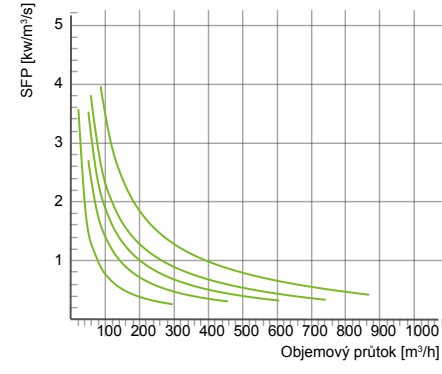
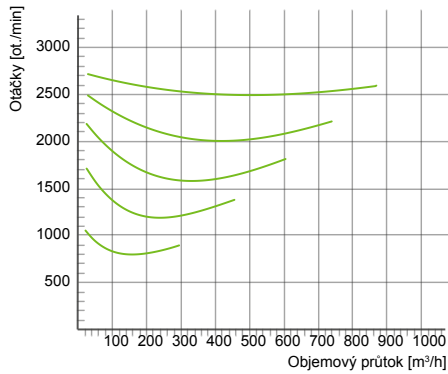
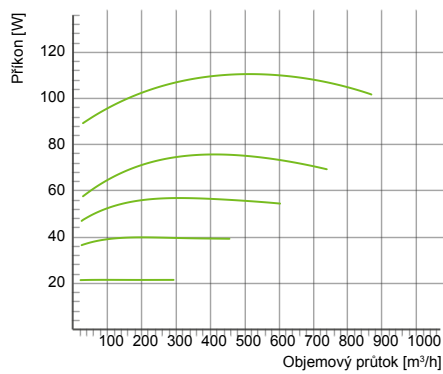
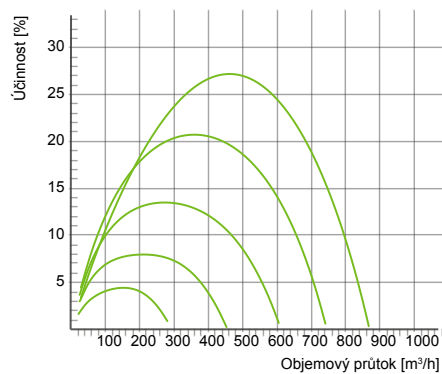
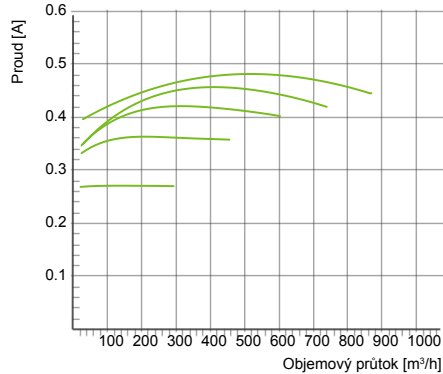
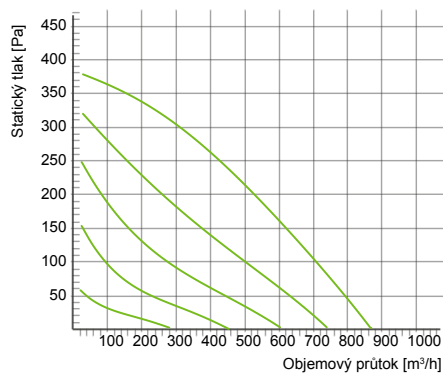

Typ	Napájení [V/Hz]	Hmotnost [kg]	Příkon [W]	Proud [A]	IP/CL	Otáčky [ot./min]	Teplota [°C]*	Napojení [mm]	Max. průtok [m³/h]	Max. tlak [Pa]	ErP 2018**
KVFU160B	230/50	2,7	62	0,27	44/F	2540	80	160	497	346	ANO
KVFU160C	230/50	3,5	111	0,48	44/F	2490	75	160	871	386	ANO

* Maximální teplota dopravovaného vzduchu, když je ventilátor regulován
** Pro splnění ErP 2018, je nutné použít SET-ERP2018

KVFU200A

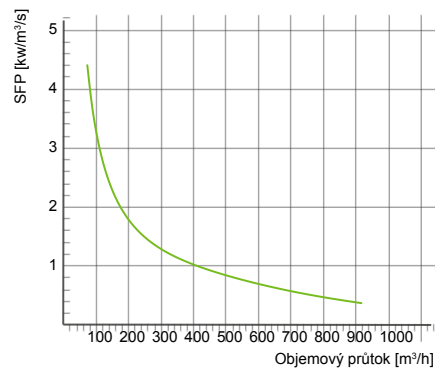
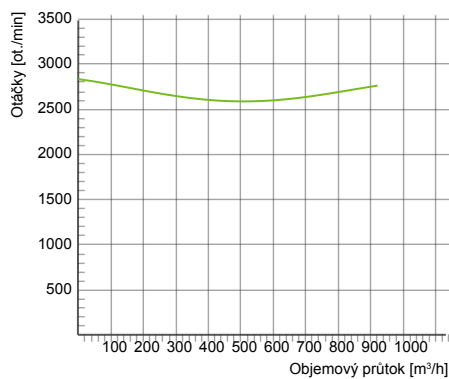
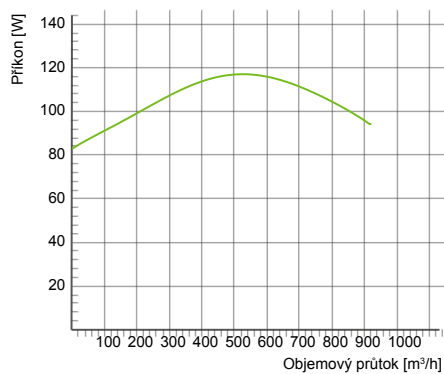
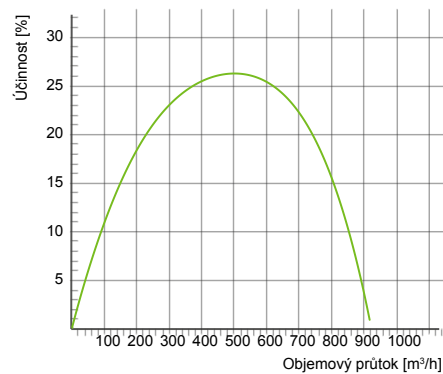
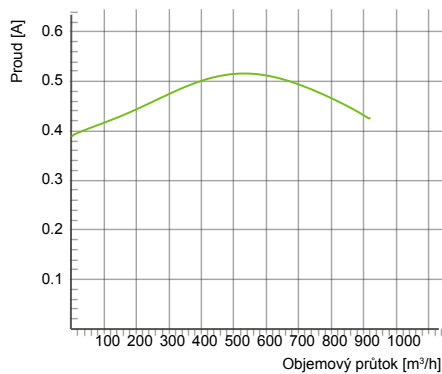
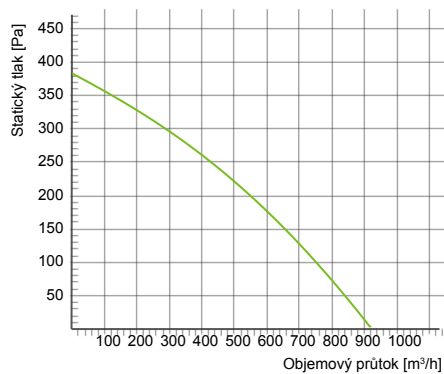

KVFU200B

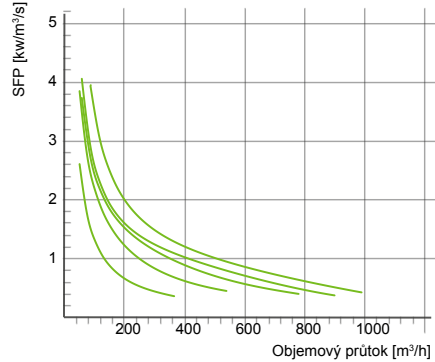
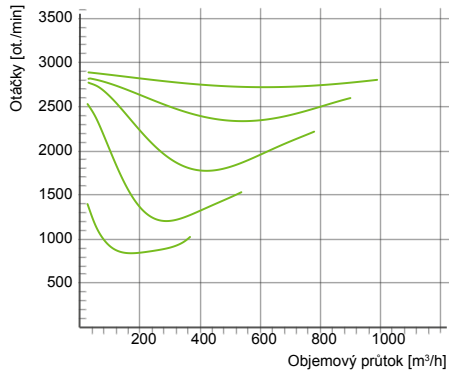
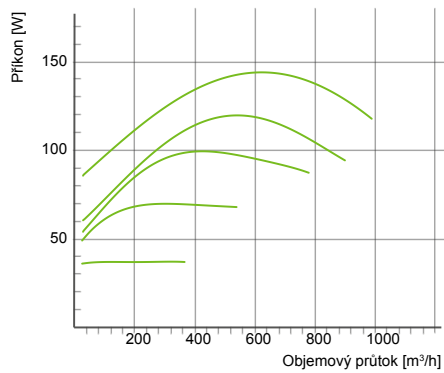
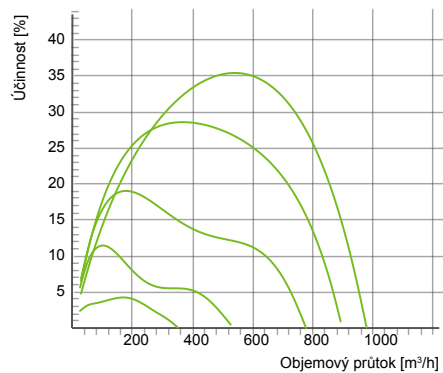
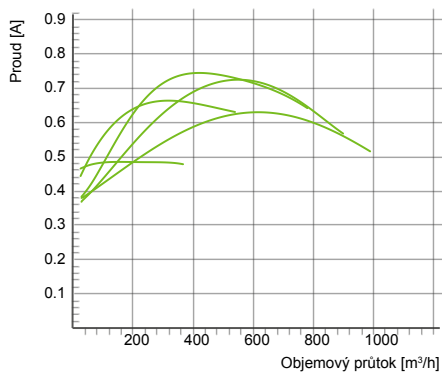
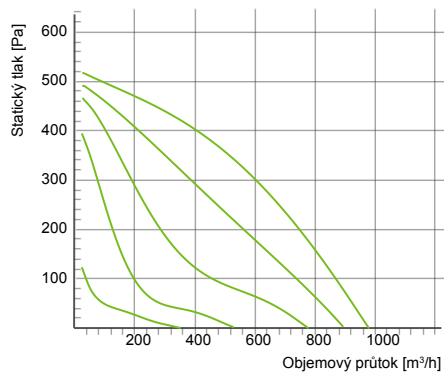

Typ	Napájení [V/Hz]	Hmotnost [kg]	Příkon [W]	Proud [A]	IP/CL	Otáčky [ot./min]	Teplota [°C]*	Napojení [mm]	Max. průtok [m³/h]	Max. tlak [Pa]
KVFU200A	230/50	3,7	132	0,59	44/F	2620	60	200	922	445
KVFU200B	230/50	4,4	144	0,63	44/F	2720	65	200	979	526

* Maximální teplota dopravaného vzduchu, když je ventilátor regulován

KVFU250A

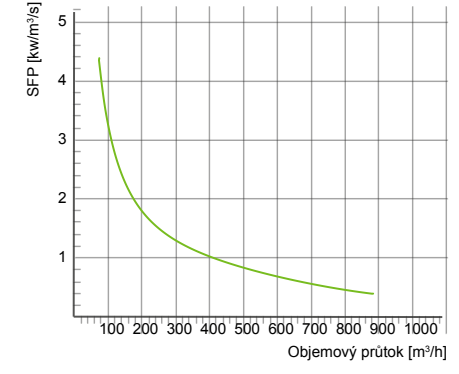
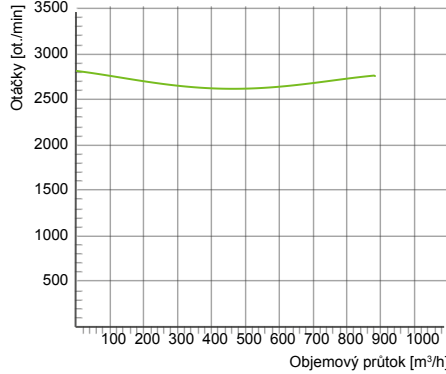
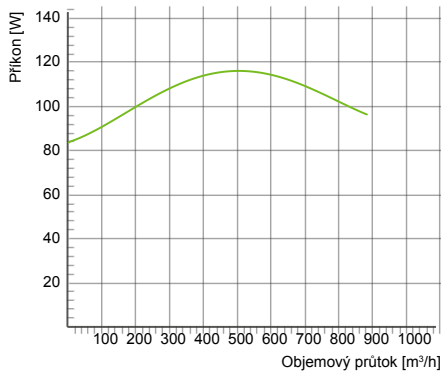
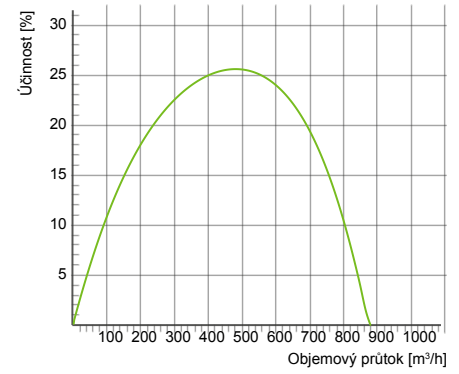
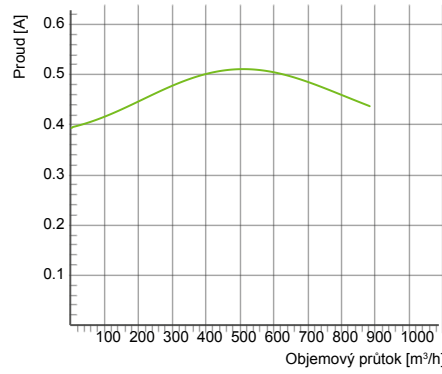
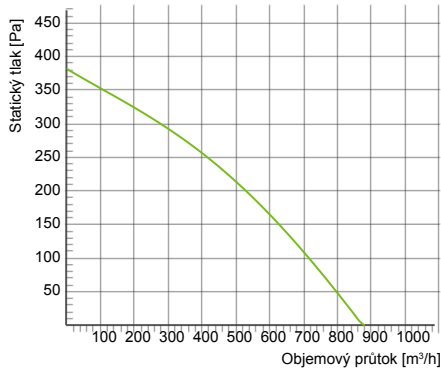

KVFU250B

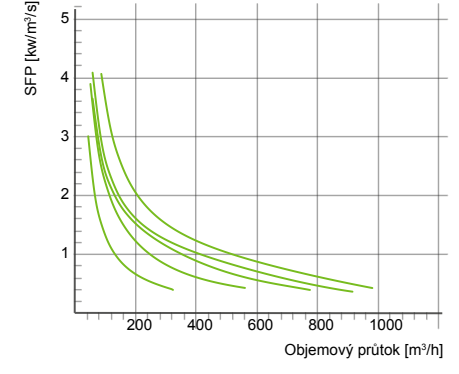
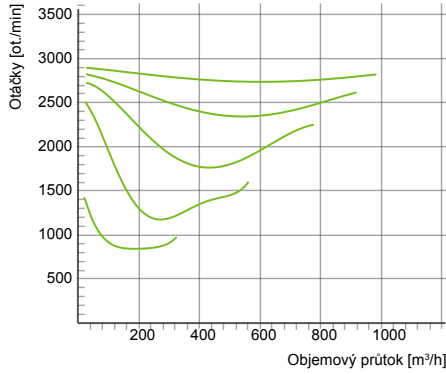
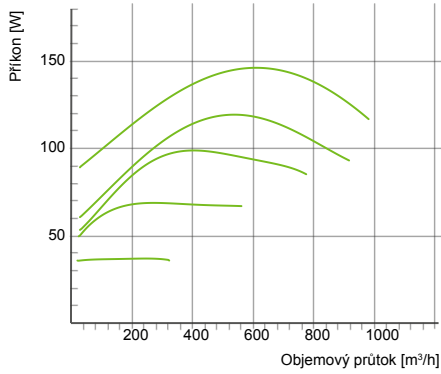
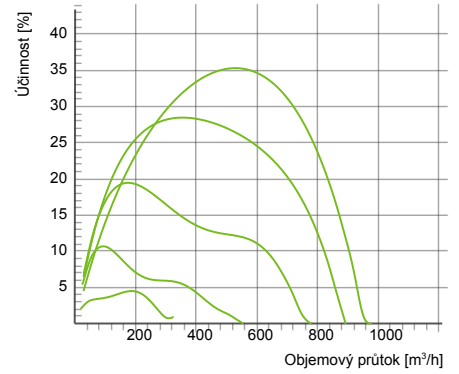
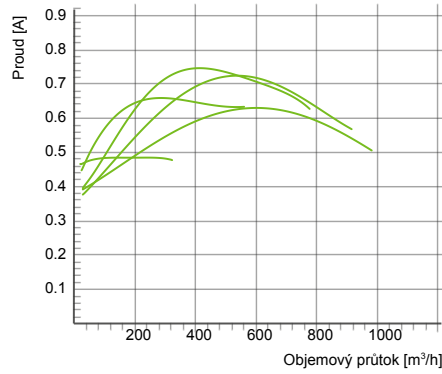
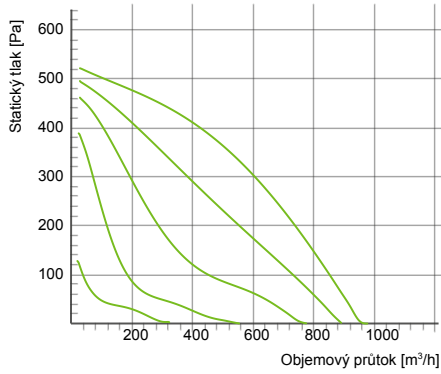

Typ	Napájení [V/Hz]	Hmotnost [kg]	Příkon [W]	Proud [A]	IP/CL	Otáčky [ot./min]	Teplota [°C]*	Napojení [mm]	Max. průtok [m³/h]	Max. tlak [Pa]
KVFU250A	230/50	3,8	130	0,58	44/F	2640	60	250	886	410
KVFU250B	230/50	4,6	146	0,63	44/F	2740	65	250	958	525

* Maximální teplota dopravovaného vzduchu, když je ventilátor regulován

3

KVFU315C

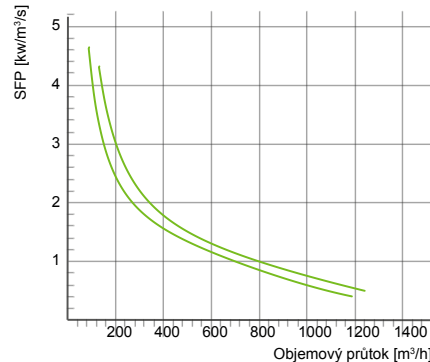
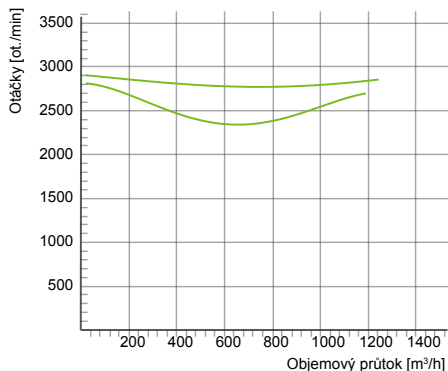
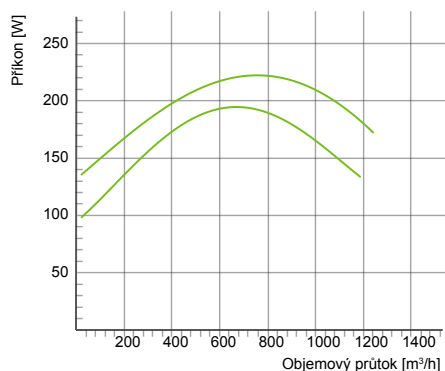
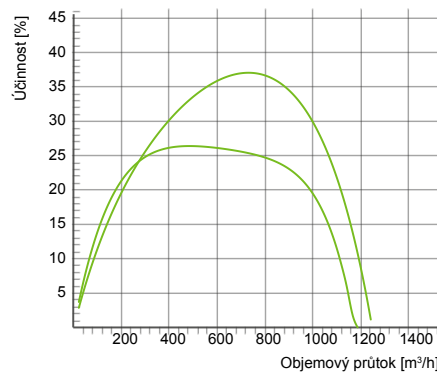
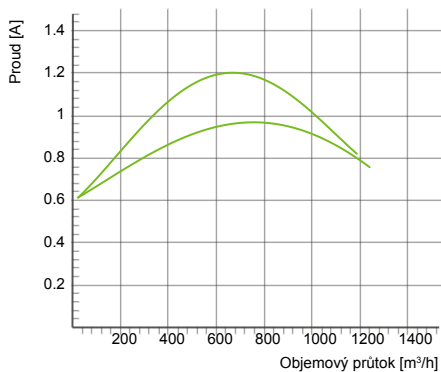
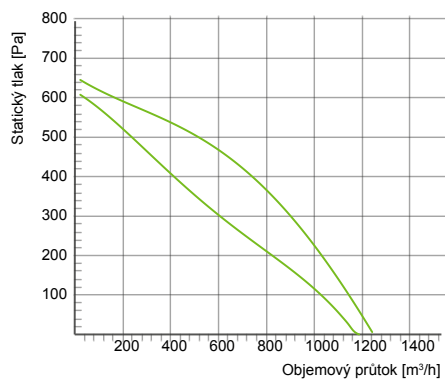

Typ	Napájení [V/Hz]	Hmotnost [kg]	Příkon [W]	Proud [A]	IP/GL	Otáčky [ot./min]	Teplota [°C]*	Napojení [mm]	Max. průtok [m³/h]	Max. tlak [Pa]
KVFU315C	230/50	5,8	222	0,97	44/F	2770	75	315	1249	657

* Maximální teplota dopravovaného vzduchu, když je ventilátor regulován

PŘÍSLUŠENSTVÍ REGULACE

TYP	Regulace		
KVFU100A	VRS 0.5	VRTE C	VRDE 1.5
KVFU100C	VRS 0.5	VRTE C	VRDE 1.5
KVFU125A	VRS 0.5	VRTE C	VRDE 1.5
KVFU125C	VRS 0.5	VRTE C	VRDE 1.5
KVFU160B	VRS 0.5	VRTE C	VRDE 1.5
KVFU160C	VRS 1.0	VRTE C	VRDE 1.5
KVFU200A	VRS 0.5	VRTE C	VRDE 1.5
KVFU200B	VRS 1.0	VRTE C	VRDE 1.5
KVFU250A	VRS 1.0	VRTE C	VRDE 1.5
KVFU250B	VRS 1.0	VRTE C	VRDE 1.5
KVFU315C	VRS 1.0	VRTE C	VRDE 1.5

VRS – Tyristorový manuální regulátor otáček, minimální rychlost nastavena pomocí šroubu pod knoflíkem



VRDE – Manuální 5-stupňový transformátorový regulátor otáček pro AC motory s 0 polohou, přepínačem vysoké/nízké otáčky a polohami (1-2-3-4-5) pro 1f motory



VRTE – Manuální 5-stupňový transformátorový regulátor otáček pro AC motory s 0 polohou a polohami (1-2-3-4-5) pro 1f motory



SCHÉMA ZAPOJENÍ

KVFU100A, KVFU125A, KVFU200A

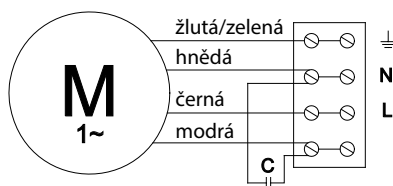

KVFU100C, KVFU125C, KVFU160B, KVFU160C, KVFU200B, KVFU250A, KVFU250B, KVFU315C

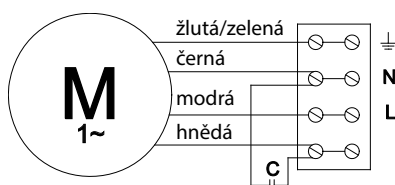

* Uvedená schémata zapojení jsou pouze orientační, vždy má vyšší prioritu schéma zapojení uvedené na výrobku

PŘÍSLUŠENSTVÍ

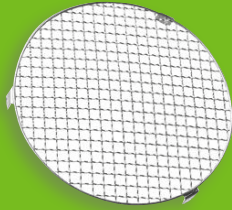

BSV
Krycí mřížka



MK
Pružná manžeta

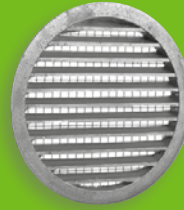

YG
Kruhová hliníková
krycí mřížka



SPT-GLX
Kruhový tlumič hluku



WSK
Samočinná žaluzie

PŘÍKLAD ZNAČENÍ

KVFU100A

- **A** – Výkonová řada
- **100** – Jmenovitý průměr
- **KVFU** – Nástěnný radiální ventilátor

